

Original Proposal.  
this proposal has  
been revised.  
DRMonette

**California-American Water  
Monterey Peninsula Water Supply Project  
Fitch Park ASR Wells 5 and 6 Above Ground  
Facilities  
Design Build Project  
Pacific Grove, CA**

**PROPOSAL FORM**

**P-1 PROJECT IDENTIFICATION:**

The project requires a Design Build Contractor (Contractor) to design, build, install complete, functional, and fully operational facilities for two Aquifer Storage and Recovery (ASR) well facilities in Seaside, California; a location map of the project sites is presented in Appendix A, Sheet T-1. The sites are currently undeveloped easement parcels along the eastern side of General Jim Moore Blvd., immediately west of Ardenes Circle.

A detailed description of each of the design elements is included in the Design Concept (Attachment A).

**P-2 THIS PROPOSAL IS TO BE SUBMITTED TO:**

CALIFORNIA AMERICAN WATER  
511 FOREST LODGE ROAD, SUITE 100  
PACIFIC GROVE, CA 93950  
Attn: Jay Drewry, Senior Buyer  
[jay.drewry@amwater.com](mailto:jay.drewry@amwater.com)

**P-3 PROPOSER'S OBLIGATIONS AND REPRESENTATIONS**

3.01 The undersigned Proposer proposes and agrees, if this Proposal is accepted, to enter into an Agreement with Owner in the form included in the Contract Documents to perform all Work as specified or indicated in the Contract Documents for the Contract Price and within the Contract Times indicated in this Proposal and in accordance with the other terms and conditions of the Contract Documents.

3.02 Proposer accepts all of the terms and conditions of the Proposal documents, including without limitation those dealing with the disposition of the Proposal security. This Proposal will remain subject to acceptance for 60 days after the day of Proposal opening. Proposer will sign and deliver the required number of counterparts of the Agreement with

any Bonds and other documents required by the Request for Proposal and Proposal Form within 15 days after the date of Owner's Notice to Proceed.

3.03 In submitting this Proposal Proposer represents and agrees, as more fully set forth in the Agreement, that:

A. Proposer has examined and carefully studied the Proposal Documents and the following Addenda (receipt of all which is hereby acknowledged)

Addendum No.	Addendum Date
1	10/09/18
2	10/21/18
3	10/29/18
4	11/04/18
5	11/26/18

B. Proposer has visited the Site and become familiar with the general, local and Site conditions that may affect cost, progress, performance and furnishing of the Work.

C. Proposer is familiar with all applicable federal, state and local Laws and Regulations that may affect cost, progress, performance and furnishing of the Work.

D. Proposer has carefully studied all available reports of explorations and tests of subsurface conditions at or contiguous to the Site and all available drawings of physical conditions relating to existing surface or subsurface structures at or contiguous to the Site which have been identified or made available by Owner.

E. Proposer is aware of the general nature of the work to be performed by Owner and others at the Site that relates to Work for which this Proposal is submitted as indicated in the Contract Documents.

F. Proposer has correlated the information known to Proposer, information and observations obtained from visits to the Site, reports and drawings identified in the Contract Documents and all additional examinations, investigations, explorations, tests, studies and data with the Contract Documents.

G. Proposer has given Owner written notice of all conflicts, errors, ambiguities or discrepancies that Proposer has discovered in the Contract Documents and the written resolution thereof by Owner is acceptable to Proposer, and the Contract Documents are generally sufficient to indicate and convey understanding of all terms and conditions for performing and furnishing the Work for which this Proposal is submitted.

H. This Proposal is genuine and not made in the interest of or on behalf of any undisclosed individual or entity and is not submitted in conformity with any agreement or rules of any group, association, organization or corporation; Proposer has not directly or indirectly induced or solicited any other Proposer to submit a false or sham Proposal; Proposer has not solicited or induced any individual or entity to refrain from submitting a

Proposal; and Proposer has not sought by collusion to obtain for itself any advantage over any other Proposer or over Owner.

P-4 CONTRACT PRICE

4.01 Proposer will complete the Work in accordance with the Contract Documents for the following price(s):

A. COST OF THE WORK

1. The Cost of all Work other than Unit Price Work shall be determined as provided in Paragraph 10.01 of the General Conditions, as revised or amended by the Supplementary Conditions and shall include the following amounts subject to increases or decreases for changes in Work as provided for in Article 8 of the Agreement

2. Lump Sum Fees

- a. Design Professional Services - Preliminary Design up to and Including Issuing of the Design Memorandum.

\$ 300,713.00

- b. Design Professional Services – Preliminary Design Completion through Final Design Phases.

\$ 511,212.00

- c. Design Professional Services – Construction/Operational Phase

\$ 436,035.00

- d. Pre-Construction Services during Design Phase

\$ 255,607.00

- e. **Total construction costs: includes Bid Form, Construction Supervision and Superintendence.**

\$ 6,118,067.00

- f. Cost of Bond Premiums (Based on construction estimate):

\$ 56,771.00

Premium unit Price \$ 8.00 /\$ 1,000.00

Range: \$ 4,000,000.00 to \$ 8,000,000.00

TOTAL LUMP SUM (a. + b. + c. + d. + e. + f.):

\$ 7,678,405.00

B. DESIGN/BUILDER's FEE

1. Lump Sum Fee \$ 817,840.00 [This amount is included in our total lump sum price]

P-5 CONTRACT TIMES

5.01 Proposer agrees that the Work will be substantially completed and ready for final payment in accordance with paragraphs 13.05 and 13.08 of the General Conditions on or before the dates or within the number of calendar days indicated in the Agreement.

Design Memo Completion: 42 days

(Insert days from Notice of Award to completion of the Design Memorandum)

Final Design Phase Completion: 140 days

(Insert days from Notice to Award to completion of the Final Design Phase)

5.02 Proposer accepts the provisions of the Agreement as to liquidated damages in the event of failure to complete the Work within the times specified in the Agreement.

P-6 EXHIBITS

6.01 The following documents are attached to and made a condition of this Proposal:

A. The individual or entity providing the Design Professional Services will be:  
(if more then one list all)

---

---

Please refer to Technical Proposal

---

---

---

---

B. Listed below are the Exhibits the Design/Builder has attached to this proposal:

---

---

Please refer to Technical Proposal

---

---

---

---

---

P-7 TERMINOLOGY

7.01 The terms used in this Proposal which are defined in the General Conditions of the Contract between Owner and Design/Builder (“General Conditions”) included as part of the Contract Documents have the meanings assigned to them in the General Conditions. Terms defined in the Request for Proposal are used with the same meaning in this Proposal.

P-8 SUBMISSION

SUBMITTED on 12/7/2018.

State Contractor License No. 667560.

State Certificate of Authority for Corporate Engineering Practice (If Applicable):

If Proposer is:

An Individual

By: N/A (SEAL)  
(Individual's Name)

doing business as \_\_\_\_\_  
Business address: \_\_\_\_\_  
\_\_\_\_\_

Phone No.: \_\_\_\_\_  
Facsimile No.: \_\_\_\_\_

A Partnership

By: N/A (SEAL)  
(Firm Name)

\_\_\_\_\_  
(general partner)

Business address: \_\_\_\_\_  
\_\_\_\_\_

Phone No.: \_\_\_\_\_  
Facsimile No.: \_\_\_\_\_

A Corporation

By: HAL HAYS CONSTRUCTION, INC. (SEAL)  
(Corporation Name)

California  
(state of incorporation)

By: Kirby S. Hays (SEAL)  
(name of person authorized to sign)

CEO  
(Title)

(Corporate Seal)

Attest Hal Hays  
(Secretary)

Business address: 4181 Latham Street  
Riverside, CA 92501

Phone No.: 951-788-0703

Facsimile No.: 951-289-7112

Date of Qualification to do business as a foreign (out-of-state) corporation in state where  
Project is located (if applicable): N/A

A Joint Venture

By: N/A (SEAL)  
(Name)

(Address)

By:  (SEAL)  
(Name)

(Address)

Business address:

Phone No.:

Facsimile No.:

(Each joint venturer must sign. The manner of signing for each individual, partnership and corporation that is a party to the joint venture should be in the manner indicated above.)

## II. INFORMATION TO BE SUBMITTED WITH THE PROPOSAL

The following minimum information must be submitted with Design/Builder's proposal for it to be accepted. Owner intends to award contract to the successful proposer.

1. Separate Lump Sum amounts for each of the following components in P-4 of the Proposal Form. **Lump Sum amounts listed below, specifically Section P-4, CONTRACT PRICE, of the Proposal Form, shall be submitted with the Proposal but in a separate, opaque, sealed envelope that is clearly marked "COST PROPOSAL ENCLOSED"**:
  - a. Design Professional Services for– Engineering through Preliminary Design Phase, up to and including issuance of the Design Memorandum. (See III. Scope of Design Services, Section A).
  - b. Design Professional Services for – Completion of Final Design Phases (See III. Scope of Design Services, Section A).
  - c. Design Professional Services - Construction/Operations Phase (See III. Scope of Design Services, Section B).
  - d. Pre-Construction Services during Design Phase - (See III. Scope of Design Services, Section B).
  - e. Supervision and Superintendence of Construction – See SC-10.01 Cost of the Work for a description of the costs to be included in this item.
  - f. Performance and Payment Bond premium based on the Design Builders estimated construction cost. Provide a premium unit price that can be used if construction cost differs from the estimated cost. Also, provide the range that unit price is valid.
  - g. Design Builders Fixed Fee
2. Provide the following Design/Build Team information relative to the proposed team qualifications:
  - a. Firms: Identify the companies in the design build team and any other companies you maybe teaming up, partnering or associating with during the project.
  - b. Design/Build/Partnering Experience: Identify the team's design/build and partnering experience, including experience on projects similar to the proposed. Include a brief description of the projects, their costs and the current names and telephone numbers of the owner or owner's contact.
  - c. Quality Management Plan Outline: Provide an organization chart showing reporting lines and responsibilities for the team. Provide references to company procedures to be used to manage the proposed project. Provide the method of management of the subcontractors. Provide the relationship of the contractor's safety plan to the above.

3. List areas of construction work which Design/Builder desires to perform with its own forces either through negotiation or successful competitive bidding against qualified subcontractors.
4. For self-performed work, provide all the classifications of labor to be employed and associated hourly unit cost inclusive of wages, fringe benefits, payroll taxes, insurance, etc.
5. Provide description of the services and facilities included in the lump sum cost of Supervision and Superintendent of Construction. Provide a Construction Phase organizational chart identifying Design/Builder Construction Supervision organization. Indicate those individuals who will be full or part-time on the project and where they will be located (i.e. on-site, office)
6. Provide a narrative description of the Design/Builder's understanding of the design concept for this facility. If the Design/Builder chooses to modify the proposed site layout included with the RFP, a drawing shall be provided to identify the proposed alternate layout. Additionally, provide specifics of any alternative design concepts, which may be proposed by the Design/Builder. The Design/Builder is encouraged to submit alternative design concepts, however, a proposal based on the defined design concept is mandatory. Should alternative proposals be submitted, preliminary sketches of the proposed facilities shall be included along with relative design and construction cost estimates comparing the alternative designs with that defined in this document.
7. Prepare a construction cost estimate of the Work, which shall be broken down by major work item, organized by Construction Specification Institute (CSI) division and major process components. This estimate will be used by the Owner to evaluate Design/Builder's understanding of the project, evaluate budget and rate impacts.
8. The anticipated number and depth of all soil borings, if any, required after award of contract.
9. Specifics of any exceptions, which are taken to items requested in this document. If no exceptions are taken, it is not necessary to reiterate the information in the Scope of Services Required.
10. A listing of drawings and specifications required for this project, with titles for each drawing.
11. A listing of all Federal, State, and local permits required for design, construction and operation of the proposed facility. Identify anticipated review time for each permit and any special requirement that may delay the process.
12. A project team organizational chart headed up by the proposed project manager and including all other engineering personnel from all disciplines who are expected to be directly associated with this project and construction supervision personnel.
13. Resumes and a work experience history of each individual identified in the project team organizational chart. Identify those individuals with Design Build Institute of America (DBIA) Designated Design-Build Professional™ Certifications. The resumes of those individuals to be associated with the instrumentation and controls design must

demonstrate their capabilities in those areas identified in the Scope of Services required for design.

14. Specific identification of any design sub-consultants that will be utilized for this project, exclusive of soil boring and survey work. If sub-consultants will be utilized, the resumes of the specific individuals will be required as well as a work experience history of their firms, including three (3) references with specific contacts and phone numbers.
15. A preliminary schedule for design, permitting, construction, testing, startup and commissioning of the project from date of award in Gantt chart form. If the time of completion desired by Owner is not acceptable, it shall be explicitly stated in the proposal. The schedule shall identify long lead time equipment and critical path to completion.
16. Identify a list of major and critical shutdowns anticipated to complete the project.
17. Concurrence that Design/Builder has read the Proposed Design/Builder Contract Documents included in the Attachments and are prepared to enter into this Agreement should Design/Builder's proposal be accepted by Owner.
18. Specific information describing how Design/Builder's firm plans to establish electronic communications with California-American Water Engineering if these capabilities are not already in place.
19. Evidence of Proposer's qualifications to do business in the State where the Project is located (See GPI-3.01).

# California American-Water Monterey Peninsula Water Supply Project Desing-Build of Fitch Park ASR Wells 5 & 6 Above Ground Facilites



**Proposal Due:  
December 7, 2018  
3:00 PM PST**



DB Replace Sewer Lift Stations



Fresno WWTP Odor Control Facility



DB Potable Water Storage Tank  
Pipelines



Earthwork, Concrete & Asphalt Paving

**Submitted To:**

**California-American Water**

Attn: Jay Drewry and Donald Monette

655 W. Broadway, Ste 1410

San Diego, CA 92101

[jay.drewry@amwater.com](mailto:jay.drewry@amwater.com)

[donal.monette@amwater.com](mailto:donal.monette@amwater.com)

619-446-4777



License No. 667560, Class: A - General Engineering, B - General Building,

C-12 - Earthwork & Paving, and C-21 - Building Moving & Demolition

Hal Hays Construction, Inc.

4181 Latham Street, Riverside, CA 92501

Contact: Kirby S. Hays, CEO

[khays@halhays.com](mailto:khays@halhays.com)

951.788.0703

**RFP Part II. Technical Exhibit**

**Original**



**CAW MONTEREY PENINSULA WATER SUPPLY PROJECT**  
**DESIGN BUILD OF FITCH PARK ASR WELLS 5 & 6 ABOVE GROUND FACILITIES**  
**SEASIDE, CA**  
**TABLE OF CONTENTS**

<b>SECTION TITLES</b>	<b>PAGE</b>
COMPANY OVERVIEW	1-2
2A DESIGN BUILD TEAM	3
2B DESIGN BUILD/ PARTNERING PAST EXPERIENCE, PROJECTS	4 -10
2C HHCI ORG CHART, QC MANAGEMENT PLAN AND SAFETY PLAN	11-15
3 HHCI SELF PERFORM TRADES	16
4 HHCI SELF PERFORM WORK LABOR RATES	17
5A SERVICES AND FACILITIES INCLUDED	18
5B FULL/PART TIME INDIVIDUALS	18
5C CONSTRUCTION PHASE ORG CHART	19
6 TECHNICAL APPROACH, PROJECT NARRATIVE	20-37
7 CSI CONSTRUCTION COST BREAKDOWN	38
8 ANTICIPATED SOIL BORINGS (IF APPLICABLE)	39
9 LIST OF EXCEPTIONS	39
10 LIST OF DRAWINGS AND SPECIFICATIONS	40-43
11 LIST OF REQUIRED PERMITS	44
12 DESIGN TEAM & SUBCONSULTANT ORG CHART	45
13 HHCI PROJECT DELIVERY TEAM	46
14 SUBCONSULTANTS UTILIZED AND PROJECT REFERENCES	47-51
15 PRELIMINARY SCHEDULE	52 /INSERT
16 LIST OF MAJOR & CRITICAL SHUTDOWNS	53
17 CONCURRENCE AGREEMENT	53
18 ELECTRONIC COMMUNICATION SPECIFICS	54-55
19 CONTRACTOR'S LICENSE INFORMATION	56
CONCLUSION	57
APPENDIX A1 HAL HAYS CONSTRUCTION TEAM RESUMES	
APPENDIX A2 LUHDORFF & SCALMANINI, CONSULTING EGI TEAM RESUME	
APPENDIX A3 SUBCONSULTANT TEAM RESUMES	
APPENDIX B SOUND ENCLOSURE	

Founded in 1991 and celebrating over 27 years of service to clients, Hal Hays Construction, Inc. (HHCI) is an award-winning design build construction company providing vertical construction and civil construction services for Public Utilities, Water Agencies, Military Government and Private clients throughout the Western states. HHCI's portfolio includes 1,000+ successful new construction, heavy civil, wet utilities, and renovation/TI projects.

Also, HHCI possesses extensive expertise in these highly relevant areas, for example, multi-site/concurrent project coordination, Design Build Services, wet utility projects: pipe lines, pump stations, and waste water treatment plants.



HHCI Headquarters, Riverside, CA



City of Fresno  
 WWTP Odor  
 Control Plant,  
 Fresno, CA

**Full Legal Name & Current Physical Business Street Address:**

**Hal Hays Construction Inc.**

4181 Latham Street, Riverside, CA 92501

**State Contractors License No. and Class:**

California State Contractors License #667560

Classifications: **A, B, C12, C21, HAZ**

Department of Industrial Relations: 1000005009



**Brief Description of the Organization's History, Capabilities, Resources, Structure, Size & Services**

HHCI is an A & B licensed General Contractor, C-12 Earthwork & Paving, C-21 Building Moving & Demolition, and HAZ certified specialty contractor.

<b>HHCI Crew &amp; Management/Admin. Team</b>	89 crew members and 78 management and administrative employees
<b>Self-Perform Trade Disciplines</b>	<ul style="list-style-type: none"> <li>▪ Demolition</li> <li>▪ General Construction</li> <li>▪ Building Construction</li> <li>▪ Renovations</li> <li>▪ Interior Work</li> <li>▪ Civil Constr.</li> <li>▪ Site Concrete</li> <li>▪ Earthwork</li> <li>▪ Asphalt Paving</li> <li>▪ Flatwork</li> <li>▪ Utilities</li> <li>▪ General Labor</li> <li>▪ Design Build</li> <li>▪ Erosion Control</li> <li>▪ BMP's</li> <li>▪ Equipment/Supply Transportation</li> <li>▪ Heavy Equipment</li> <li>▪ Traffic Control</li> </ul>
<b>Heavy Equipment Fleet</b>	\$13.7M Heavy Equipment Fleet, comprised of 289 pieces of owned, maintained, and operated Heavy Equipment.
<b>Equipment &amp; Supply Transportation</b>	Equipment and supply transportation services via 15 CARB-Compliant truck/trailer assets, including 86 Service Vehicles.

As a long-term design builder, specializing in heavy horizontal civil and wet utility projects, HHCI successfully performs work throughout California American Water Company's geographical footprint.



## HHCI Accomplishments & Accreditations

Our loyal clients choose HHCI as the ‘go to’ team based on our stellar performance and industry accolades, such as:



2018 NMSDC Class IV (\$50M+) National Supplier of the Year



2018, 2017, 2016 & 2015 Edison Supplier of the Year & 2016 NMSDC Western Reg. Supplier of the Year



2016 US Dept. of Commerce/MBDA *Contractor of the Year* and *MBE of the Year*



ENR-Ranked Top California Contractor (8-time honoree)



INC 5000 High Growth Firm (2-time honoree)



Associated Builders & Contractors (1) STEP Gold Safety Certified, and (2) Accredited Quality Contractor Certified



Diversity Awards-7<sup>th</sup> Largest Native American Firm & Top Diversity Business in CA & USA



ISNetworld “A” Grade Certified-active membership and A grade rating



Avetta “Green Flag” status for both safety & insurance

## HHCI's Diverse Business Enterprise Certification

HHCI is a **certified Diverse Business Enterprise/Minority Business Enterprise (DBE/MBE)** in good standing by the National Minority Supplier Development Council (NMSDC) and The Supplier Clearinghouse (CPUC) for the California Public Utilities Commission.

As a leading DBE/MBE, HHCI has earned the following prestigious awards:

- In October 2018 and 2016, HHCI was honored to earn selection as the **National Minority Supplier Development Council’s (NMSDC) National & Western Region Class 4 Supplier of the Year** awardee.
- **July 2018 SCMSDC Class IV(\$50M+) Supplier of the Year (SOTY) Award: Hal Hays Construction Inc.**, was awarded for the third year in a row, the, nominated by SCE.
- In October 2016, HHCI was selected as the US Department of Commerce-Minority Business Development Agency **(1) 2016 DBE/MBE National General Contractor of the Year**, and **(2) 2016 Fresno DBE/MBE Firm of the Year**.



SCMSDC President & SCE, presenting HHCI with 2018 Class IV Supplier of the Year Award

*July 25, 2018 “Congratulations to all of our MBE nominees for their exceptional achievements and to the corporate members who nominated them, these partnerships have delivered tangible results and economic impacts in the community... – it’s a testament to their commitment to supplier diversity and inclusion.”*

**SCMSDC President Virginia Gomez**



## II. INFORMATION TO BE SUBMITTED WITH THE PROPOSAL

*The following minimum information must be submitted with Design/Builder's proposal for it to be accepted. Owner intends to award contract to the successful proposer.*

*Provide the following Design/Build Team information relative to the proposed team qualifications:*

- a. Firms: Identify the companies in the design build team and any other companies you intend to team up, partnering or associating with during the project.*

### Project Delivery Team Overview:

HHCI's key Project Delivery Team member firms include:

- **Hal Hays Construction Inc.** as **Design-Builder/Prime Contractor**
- **Luhdorff and Scalmanini, Consulting Engineers** as **Designer of Record (DOR) and Civil & Electrical Design/Engineers**

For this project, HHCI has assembled a Project Delivery Team who has **extensive working knowledge** and a clear project understanding.

**Hal Hays Construction, Inc. (HHCI):** HHCI possesses long-term expertise in **design-build horizontal and wet utility construction projects** with **1000+** completed projects valued at over **\$862 Million**. HHCI has over **27 years** of heavy horizontal and wet utility construction experience, including **pump stations, water reservoirs, pipe lines, work within environmentally sensitive areas, and minimization of soil disturbance.**

**Luhdorff and Scalmanini, Consulting Engineers (LSCE):** Founded in 1980, LSCE is a **civil engineering and hydrogeologic** consulting firm that specializes in the design and construction of water production facilities and groundwater resource investigation and development. LSCE's design approach has been refined through completion of hundreds of well and pump station projects and high-capacity booster pump production facilities located throughout California.

**HHCI/LSCE** will address the following design build requirements of this RFP:

- Review and incorporate the basic project features described in the RFP into the project.
- Evaluate and analyze the preliminary design information provided in the RFP and assess the validity and accuracy of the preliminary design with the D-B's proposed project design.
- Incorporate CAW's standard design practices and standard materials/manufacturers into project engineering, final design and construction.

In preparation for this proposal, HHCI conducted a site visit, reviewed the Government's RFP, related materials and subsequent amendments, conducted **6** proposal development and technical approach strategy meetings to formulate a solid understanding of the project requirements and devise the safest, quality-oriented, sustainable and cost-conscious project solution.

Additionally, the **HHCI** Project Delivery Team has delivered **163 design build projects, valued at \$300 Million** that include the relevant work scope areas of: multi-disciplinary design, wet utilities, and heavy-civil work, including projects at various **federal military bases, state of the art aerospace facilities, and multiple public utility agencies.**



*b. Design/Build/Partnering Experience: Identify the team’s design/ build and partnering experience, including experience on projects similar to the proposed. Include a brief description of the projects, their costs and the current names and telephone numbers of the owner or owner’s contact.*

The following projects demonstrate the abilities **HHCI** has in order to provide the support and drive to construct a design build project. Working with these different entities has allowed our team to further excel and continuously improve in the realm of Design-Build.

**Project 1: Repair Point Mugu Main Water Pump Station**



<b>Project Owner</b>	<b>Navy Facilities Engineering Command (NAVFAC)</b>
<b>Location of Project</b>	Point Mugu Marine Corps Base Ventura County, CA
<b>Brief Description of the Work Involved</b>	<p>Hal Hays Construction, Inc. (HHCI) served as the Prime Contractor to repair the main water pump station at Naval Base Ventura County, Point Mugu CA. This project consisted of : Demo of sand separators and three steel tanks; Potable Pipelines and connections; Chemical stations; Electrical utility upgrades; new 12-inch HDPE piping; new 700,000-gallon potable water tank; SCADA; 1,500 L.F. of 12-inch pipe installation, connections to active well, 350 PSI high pressure pipeline, Project required customer shutdowns of piping system which was completed in one day, dewatering, water imported from Port Hueneme Water Agency (PHWA) to the military base.</p> <p>**This project was completed on time with ZERO safety incidents.</p>
<b>Contract Amount</b>	\$3.7M
<b>Date of Completion of Contract</b>	August 2016
<b>Reference Contact Name and Phone number</b>	Veronica Rindge, Construction Manager Phone: (805) 982-3927 veronica.rindge@navy.mil





**Project 2: Design-Build Repair Waste Water Systems at Taps 1, 2, & 3, Marine Corps Base**



<b>Project Owner</b>	Navy Facilities Engineering Command (NAVFAC)
<b>Location of Project</b>	Camp Pendleton, CA
<b>Brief Description of the Work Involved</b>	 <p>HHCI assembled a Project Delivery Team who has extensive Camp Pendleton working knowledge and understood the project to provide design and construction of emergency wastewater overflow systems to three wastewater collection sites, TAPS 1, 2, and 3, at MCB Camp Pendleton. As part of HHCI's role in this project, our team <b>demolished and disposed of metal devices</b> within the existing clarifiers, renovated to <b>permanently plug and seal sludge draw-off line</b>. Additional renovations were made to <b>install safety gates at demolished walkways</b>; installation of air gap systems and of gravity overflow piping at TAPS 1 and 2; and installation of a new sewer manhole at TAPS 2.</p>
<b>Contract Amount</b>	\$381,000
<b>Date of Completion of Contract</b>	June 2014
<b>Reference Contact Name and Phone number</b>	Ryan Thermus Michael Baker International 9755 Clairemont Mesa Blvd Suite 100 San Diego, CA 92124 rthurmes@mbakerintl.com (858) 614-5053



**Project 3: Design-Build Repair/Replace Multiple Sewer Lift Stations and Piping Systems**



<b>Project Owner</b>	<b>United States Army Corps of Engineers</b>
<b>Location of Project</b>	Military Ocean Terminal Concord, CA
<b>Brief Description of the Work Involved</b>   <b>US Army Corps of Engineers®</b>	<p>HHCI served as the Prime Contractor to the Army Corps of Engineers to design and construct two new sewer lift stations. Working closely with the designer of record, we directed the design to where it was most economical to construct while meeting all the design requirements. The larger of the lift stations required an <b>excavation to 22' deep</b>, only 5' away from the edge of a primary roadway and located directly under high power electrical lines high overhead, with groundwater encountered at approximately 12' depth. This made the installation risky and difficult. We chose a shoring system that allowed us to excavate and build the shoring from the inside of the excavation.</p> <p>**This project was completed on time with <b>ZERO</b> safety incidents.</p>
<b>Contract Amount</b>	\$2.1M
<b>Date of Completion of Contract</b>	March 2014
<b>Reference Contact Name and Phone number</b>	Erik T Reitter, PE AMEC Foster Wheeler Environment & Infrastructure, Inc. 271 Mill Road Chelmsford, MA 01824 Eric.reitter@amecfw.com (978) 467-5757



**Project 4: DB Repair Training Tank, Building 62517, 62 Area, Marine Corps Base**



<b>Project Owner</b>	Navy Facilities Engineering Command (NAVFAC)
<b>Location of Project</b>	Camp Pendleton, CA
<b>Brief Description of the Work Involved</b>	<p>HHCI's Project Delivery Team understood this project consisted of repairing 62517 Training Tank in the 62 Area of Camp Pendleton. The project included <b>demolition, replacement, and repairs</b> to the existing men's and women's bathhouse, swim tank, tank equipment, jumping tower, deck and perimeter wall. HHCI's design build methodology for this project included separate phases: <b>conceptual planning and estimating, design development, pre-construction, and construction</b>. HHCI replaced damaged and uneven pool decking, and the perimeter wall. Of significance, the design build approach, maximized the interior spaces of the bathhouses building, upgrading the building for seismic requirements and meeting the requirement of all aspects of the American with Disabilities Act Accessibility Guidelines.</p>
<b>Contract Amount</b>	\$2M
<b>Date of Completion of Contract</b>	May 2012
<b>Reference Contact Name and Phone number</b>	<p>Gary Congdon                  Lee &amp; Sakahara Architects                  6280 S Valley View Blvd                  Las Vegas, NV 89118                  gcongdon@leesalv.com                  (702) 270-6600</p>





The following projects demonstrate LSCE’s extensive knowledge, past performance and experience, as well as the firm’s experience in working with large organizations such as: **Discovery Bay Community Services District**, **Diablo Water District**, and **Sacramento Suburban Water District** many more.

**Project 1: Newport Drive Water Treatment Plant & Willow Lake Water Treatment Plant**



<b>Project Owner</b>	<b>Discovery Bay Community Services District</b>
<b>Location of Project</b>	Discovery Bay, CA
<b>Brief Description of the Work Involved</b>	<p>LSCE provided design and construction management of new groundwater wells to replace aging wells and expand reliability for anticipated developments within the community. LSCE provided the complete permitting, environmental review, design and construction for hydrogeologic test holes, monitoring wells, and pump facilities. Prior to construction of the production well, three separate monitoring wells were installed, screened at specific elevations in the aquifer strata, to evaluate the water quality characteristics. The principal design objectives for the wells in Discovery Bay is the identification and exclusion of aquifer units that could potentially yield shallow contaminant plumes and naturally corrosive and brackish water. Water quality concerns were investigated and identified in shallow groundwater, shallow zone water monitoring wells were installed and the production well was designed to prevent downward movement of contaminants. Each well is approximately 360-foot deep, with 18-inch diameter casing, equipped with a 150 horsepower and 200 horsepower submersible pump components, with production rated to 3 MGD per well</p>
<b>Contract Amount</b>	\$10M
<b>Date of Completion of Contract</b>	2012 & 2016
<b>Reference Contact Name and Phone number</b>	<p>Virgil Koehne, Facilities Manager                  (925) 683-3619                  vk1800todb@sbcglobal.net                  1800 Willow Lake Blvd.                  Discovery Bay, CA 94505</p>





## Project 2: Stone Creek & Glen Park Well Stations



<b>Project Owner</b>	<b>Diablo Water District</b>
<b>Location of Project</b>	Discovery Bay, CA
<b>Brief Description of the Work Involved</b>	<p>LSCE provided overall management, <b>design and construction services</b> of a <b>new groundwater well, transmission pipeline, pump station and general site improvements</b>. Each well was approximately <b>300 feet deep with 16-inch well casing</b>, and each pump station could provide <b>2 MGD with 200 HP submersible pump and motors</b>. LSCE had regular communication with city, county, fire and water district officials for permitting of a new well station building and water supply facility. The facilities included <b>CMU block building</b> with landscape and architectural features to blend into the surround into the park and residential community.</p>
<b>Contract Amount</b>	\$4M
<b>Date of Completion of Contract</b>	2011
<b>Reference Contact Name and Phone number</b>	<p>Mike Yeraka, General Manager                  (925) 625-6159                  Mikegm1@aol.com                  87 Carol Lane                  Oakley, CA 94561</p>





### Project 3: Delta Coves Booster Station



<b>Project Owner</b>	<b>Sacramento Suburban Water District</b>
<b>Location of Project</b>	Sacramento, CA
<b>Brief Description of the Work Involved</b>	<p>LSCE provided design and construction/project management services for a combination <b>5-million gallon welded steel reservoir</b> and <b>30 MGD booster pump station</b> consisting of ten, 60 through 150 horsepower can booster vertical turbine pumps. The booster station included the construction of a <b>large underground metering/valve</b> station to allow the transfer of treated surface water from the neighboring City of Sacramento water system or allow the ability to pump treated groundwater from the SSWD system to the City of Sacramento.</p>
<b>Contract Amount</b>	\$7M
<b>Date of Completion of Contract</b>	2005
<b>Reference Contact Name and Phone number</b>	<p>Jim Arenz, Senior Project Manager                  (916) 679-2880                  jarenz@sswd.org                  3701 Marconi Blvd.                  Sacramento, CA 95821</p>



c. *Quality Management Plan Outline: Provide an organization chart showing reporting lines and responsibilities for the team. Provide references to company procedures to be used to manage the proposed project. Provide the method of the subcontractors. Provide the relationship of the contractor's safety plan to the above.*

HHCI's projects are led by a **Project Executive, Operation Manager, Project Manager, onsite Superintendent/QCM/Site Safety Rep., and Project Engineer** who assure each project phase is seamlessly connected. Please see below Organizational Chart and hierarchy illustrating HHCI's Project Delivery Team.

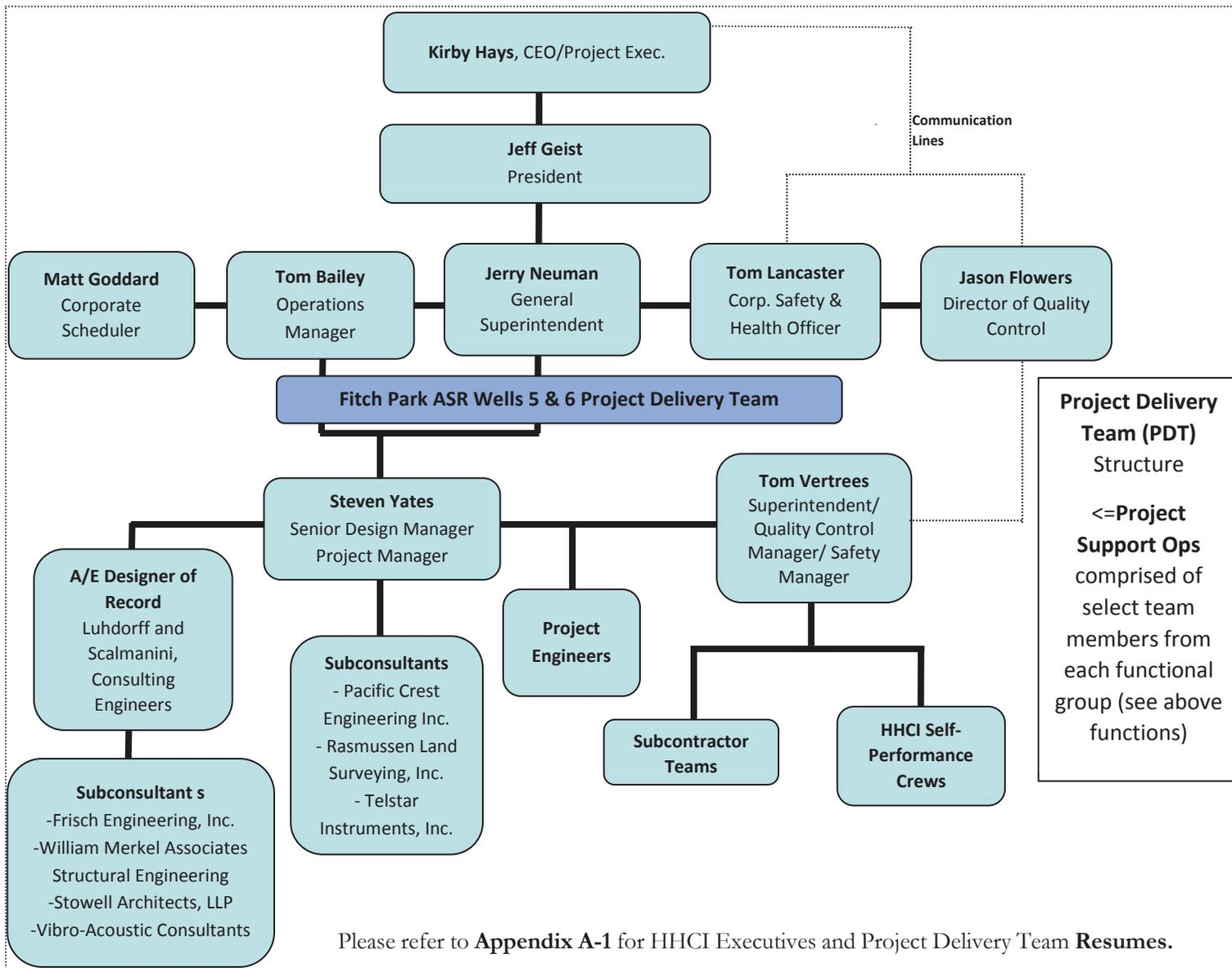

The corporate headquarters serves as the central location for all **administrative, accounting and contractual processes, primary estimating, and program and executive management**. The **Project Delivery Team (PDT)** is assigned specific resources from **Executive & Program Mgmt., QC & Safety Mgmt., Project Management, A/E Design, and Project Support Ops** teams, including: **Admin., IT, Proposal Development, Subcontracts, Finance & Accounting, Scheduling, Dispatch, HR, Equip. Mgmt., Close Out, Project Controls, Estimating and Contracts**. This matrix organization represents a **proven strategy** to achieve construction management of HHCI's numerous, geographically-dispersed projects.



### Quality Control Program & Commissioning Programs

HHCI management executives and its team members have conducted **thousands of projects requiring complex quality control programs** with outstanding results, **QC documents submitted and approved** at first submission, and **industry-approved templates** for various QC plans and submittals. This long-term prior experience provides the team with **extensive knowledge and experience** in assuring comprehensive quality control.

**The Corporate Quality Control Manager**, leads the firm's Quality Control Management program, defining QC processes, documentation, tracking, inspection, testing, and administration requirements. The project's Superintendent/Quality Control Manager (QCM) implements the quality control plan, inspection process, and oversees **each subcontractor's** QC plan. The Superintendent/QCM possesses authority to **stop work** for non-compliance. Also, QCMs are **trained/certified** by the Department of Defense to conduct construction QC programs and coordinate required Inspector's observations, testing, and inspections.

### Procedures & Tools

- Specific quality control plans are developed by the Corporate QC Manager, with approval by the HHCI Program Manager. Each **definable feature of work (DFOW)** is inspected according to a **3 Phases of Control** QC system, comprised of (1) preparatory, (2) initial, and (3) follow-up inspection phases. All non-complying items are documented on the **rework list** with the date, action taken/resolution, and date resolved.
- QC Plans delineate these procedures/requirements (**not all-inclusive list**):
  - Submittals
  - Control, Verification, and Acceptance Testing
  - Tracking, Deficiencies, and Reporting
  - Coordination Meetings
  - QC Staffing Duties & Responsibilities
  - Testing Procedure & Laboratories
  - Documentation
  - Notification/Correction of Non-Compliant Work

For all projects, The CQCM will be responsible for setting the quality standards for construction and renovation projects. The Site Superintendent/Quality Control Manager, or their designee, is assigned the responsibility of implementing the quality inspection process. As a HHCI policy, **Site Superintendent/QC Managers maintain the authority to stop work for non-compliance with contract requirements or HHCI standards.**

The Site Superintendent/QCM reports to the Project Manager, but, can also seek remedy through communication with **HHCI's Corporate QC Manager, President/CEO, or Operations Manager.**

In addition, **Design Engineers are utilized** for shop drawing review, technical consultation, and QC System Support duties (for example Geotechnical Engineers).

Specific **Quality Assurance** duties for this project may include: **concrete testing, compaction testing, and asphalt testing**, to name a few examples.

### Safety Program Certifications & Industry-Leading Accomplishments

HHCI understands its responsibility to, at all times, maintain a safe working environment at the jobsite, encompassing strict enforcement of environmental, safety, and health requirements of the Environmental Protection Agency (EPA), Occupational Safety and Health Administration (OSHA), and other applicable regulations.

### HHCI Project Safety Process & Procedures

HHCI's **award-winning safety programs** are led by **Corporate Safety & Health Officer, a Certified OSHA 500 Trainer with 11 years of industry and field experience**. He oversees HHCI's **16 Site Safety and Health Officers'** compliance with current safety standards, site security, record keeping, and accident reporting.

Among other safety duties, HHCI CSHO creates and implements HHCI's **Corporate Safety Program**, providing direction and requirements to maintain a **safe work environment** for employees, subcontractors, customers and the public. The Corporate Safety Program includes specific safety manuals, including: (1) **Injury and Illness Prevention Program (IIPP)**; (2) **Code of Safe Practices**; (3) **Emergency Procedures**; (4) **Confined Space Procedures**; (5) **Fall Protection Program**; (6) **Excavating and Trenching Program**; (7) **Standard Safety Forms**; and (8) **Safety Data Sheets**.

In addition to HHCI's Corporate Safety Program guidance, **each** project requires a **Site-Specific Safety Plan**, including **Activity Hazard Analysis, accident prevention plan, and environmental protection plan**.

For this CAW projects, the CSHO and the Site Safety Health Officer will apply safety to HHCI's project by:

- Enforcing HHCI's **IIPP** encompassing: Responsibility, Compliance, Communication, Hazard Assessment, Accident/Exposure Investigation, Hazard Correction, Training, and Recordkeeping
- Conducting all operations in accordance with **applicable safety and health regulations**.
- Ensuring projects' health and safety aspects are reviewed and approved by **qualified personnel**.
- Ensuring that employees are **trained and adequately informed** of the hazards associated with their work, including **demolition, excavation and trenching, fall protection, heavy equipment safety, and SDS** (i.e. asphalt, cement, adhesives, and solvents).
- Providing direction about **site** emergency procedures and fire, explosion, health, safety, or other hazards.
- Ensuring that all necessary **respiratory and personal protective equipment (PPE)** are available on site.
- Reporting all **accidents, exposures or near misses** to HHCI Leadership, Project Mgmt., Client, and authorities.
- **Stopping work** at a project where unsafe conditions exist.
- Reporting to the Project Manager **any** health and safety concerns associated with projects and recommending topics to be addressed during weekly safety training.

HHCI maintains a trained pool of **16 team members** to serve as Site Safety & Health Officers, with credentials that include: OSHA 10 and 30 Hour certification; EMR 385-1-1 40 Hour training, environmental training, and respective safety certifications such as **excavation and trenching, heavy equipment operations, HAZMAT, and PPE**.

### How HHCI Creates Project-Site Safety Culture

Along with the standard requirements for Safety Programs (Site Safety Plan, AHA, APP, I&IPP), the following bullet points describe HHCI's methods to establish a **project-site safety culture**:

- **Subcontractor Participation in Health & Safety Areas:** Project health and safety aspects are reviewed and approved by **qualified** subcontractor personnel. **Tier 1 and 2 Subcontractors** are required to prepare **Site Specific Safety Plans** and **AHA's**. HHCI performs safety preparatory meetings with **Subcontractor Foreman and safety representatives** before work begins. SSHO's and Subcontractors perform **on-site inspections** to ensure Health and Safety Program implementation and attend safety tailgate meetings.
- **Subcontractor Collaboration:** **1<sup>st</sup> & 2<sup>nd</sup> Tier subcontractors collaborate** with HHCI during **work plan, safety plan, quality control plan, and schedule creation** to develop safety strategies and activity sequencing that supports safe operations.
- **Authority to Stop Work Program:** Any project delivery team member can **stop work** if there is an **unsafe condition**. Team members carry a laminated card that states: **AUTHORITY TO STOP WORK**, with team member's name inserted in the following statement: ***I, (insert name), am authorized by HHCI to stop work if any unsafe conditions are present or any unsafe practices are being used.***
- **Buddy System:** Employment of the **buddy system** to help team members perform work functions in a safer manner and as a "spotter" on site to act as a second pair of eyes.



- **Subcontract Safety Clause:** As part of its subcontract documents, HHCI requires “Maintenance of Safety” as a **team contractual obligation** for all HHCI subcontractor team members.
- **Equipment/Tools Inspection Checklist and O&M Manuals:** **Equipment readiness** is inspected prior to being put in service, including submission of a checklist. Equipment/tools are inspected for frayed cords, faulty safety mechanisms, tire condition, and maintenance issues. **Operational manuals** for equipment and **SDS Sheets** are onsite for reference.
- **Free Safety Training & Consultation:** Provided to subcontractor team members by HHCI Corporate Safety Officer, an **OSHA 500 trained** and **certified safety professional**.
- **Verification:** HHCI’s Site Safety Mgr. **verifies safe operations** for subcontracted work, and the Corporate Safety Officer **spot checks** job sites semi-regularly, along with **scheduled visits** and **onsite training**.
- **Accident Reporting:** Subcontractors are required to **report all accidents, exposures, or near misses** to HHCI Site Safety Officer and Corporate Safety Officer for documentation and mitigation strategies.
- **Safety Committee:** The Corporate Safety Officer, Operations Managers, PMs, SSHOs, Superintendents, Crew, and Office Staff attend Safety Committee meetings to: update corporate-wide safety programs, procedures, and reports; review staff and subcontractor safety performance; and create safety innovations.
- **SSHO Monitoring & Safety Orientation:** SSHO inspects subcontractor’s licenses, certificates, ability to perform duties, and equipment. **Safety orientations/tailboards** are conducted before work begins.
- Safety adherence is a “**Condition of Employment**” for all HHCI team members
- HHCI team members’ **annual performance review** includes a safety component that HHCI’s employees are measured against before earning bonus, wage or salary increases
- **Zero-tolerance** drug testing, conducted by **certified drug testing agencies**

## Safety Accomplishments

Demonstrating HHCI's **safety accomplishments**, HHCI has achieved **24 Navy Safety STAR Awards**, and **Associated Builders & Contractors (ABC)** certifications for: (1) **STEP Gold Level Safety Program**, which benchmarks HHCI's Safety Program and Safety Record as **exceeding industry standards and performance averages**, and (2) **Accredited Quality Contractor**, for the firm's exceptional operational, safety, and community standards.



**STAR Safety Award**



**ABC STEP Certificate**



**ABC AQC Certificate**

In addition, HHCI utilizes the following tools in support of safe operations:

- HHCI pledged its support and is signatory to the **Construction Coalition for a Drug- and Alcohol-Free Workplace**, to eliminate substance abuse-related incidences in the workplace.
- **Pre-employment drug testing and physicals** by **US HealthWorks** and **Concentra**, including rapid 5 panel drug test, basic physical (vitals, Snellen eye test, and audiogram), and physical abilities test. For our drivers HHCI participates in the **Department of Transportation** program for random drug testing. Also, if we have reasonable suspicion or an accident occurs, HHCI sends employees for drug and/or breath/alcohol testing.
- **E-Verify System**: All HHCI employees are electronically verified by the **Department of Homeland Security** to confirm their identity and eligibility to work in the United States.

3. List areas of construction work which Design/Builder desires to perform with its own forces either through negotiation or successful competitive bidding against qualified subcontractors.

HHCI possesses **multiple in-house crews**, specializing in: **demolition, site construction, heavy civil work, utilities, concrete and asphalt paving, interior work, general labor, and equipment/supply transportation**, as well as a **\$13.7M heavy equipment fleet**.

HHCI will select from its **89 self-performing in-house crew members** to mobilize the project **without interruption** to operations and to meet the fast-paced tempo required by the project. HHCI's crews deliver successful projects because they have **worked together on relevant projects** and share established **work processes** and **problem-solving skills**.

For the **Fitch Park ASR Wells 5 & 6** project, HHCI will **self-perform** the following **work activities**:

- **Project Management**
- **Demolition**
- **Structural Concrete\*\***
- **Site Concrete\*\***
- **Yard Piping**
- **Equipment Installation**
- **Site Utilities (Sewer Waste, Water, Gas, Storm, Drain) \*\***

***\*\*This work area will be resourced dependent upon subcontractor bid competitiveness versus HHCI's costs for self-performance***

The team's proven **excellent safety records** and **outstanding project evaluations** further demonstrate the capability and experience of **its in-house crews** to **deliver a safe and quality project**.



4. For self-performed work, provide all the classifications of labor to be employed and associated hourly unit cost inclusive of wages, fringe benefits, payroll taxes, insurance, etc.

Below are all the classifications of labor and the associated hourly rates for HHCI self-performed work:

Position	Hourly Unit	Hourly Rate
Supervisor	Straight Time	91.56
Supervisor	Overtime	124.34
Supervisor	Double-time	153.05
Foreman	Straight Time	74.45
Foreman	Overtime	104.07
Foreman	Double-time	123.70
Plumber or Pipefitter	Straight Time	67.98
Plumber or Pipefitter	Overtime	95.06
Plumber or Pipefitter	Double-time	113.00
Equipment Operator	Straight Time	81.86
Equipment Operator	Overtime	114.75
Equipment Operator	Double-time	136.38
Welder	Straight Time	76.18
Welder	Overtime	103.25
Welder	Double-time	126.98
Teamster	Straight Time	53.59
Teamster	Overtime	74.35
Teamster	Double-time	88.21
Flagman	Straight Time	54.04
Flagman	Overtime	74.24
Flagman	Double-time	87.70
Laborer	Straight Time	56.19
Laborer	Overtime	77.25
Laborer	Double-time	91.33



5. Provide description of the services and facilities included in the lump sum cost of Supervision and Superintendent of Construction. Provide a Construction Phase organizational chart identifying Design/Builder Construction Supervision organization. Indicate those individuals who will be full or part-time on the project and where they will be located (i.e. on-site, office).

As part of the lump sum fee referred in **P-4 Section 2E**, the following bullet points describe the services and facilities regarding Supervision and Superintendent of Construction:

- Superintendent, Project Manager, Project Engineer
- Lodging
- Storage Container
- Portable Toilets
- Office Trailer

**Professional Liability Insurance (Error and Omission):**

Per the RFP, the Design/Builder shall carry Professional Liability Insurance, HHCI will adhere to this requirement and include such fees in proposal price. However, should the **owner waive** the Professional Liability Insurance requirement, HHCI will give the owner a **credit of \$25,000.00**

All corporate HHCI team members will participate throughout this project to assure that any matters are handled accordingly and in due time. In order to conduct such matters, a breakdown is provided to illustrate the dedication HHCI has to complete this project to its best potential:

HHCI Corporate Member	Title	Involvement
Kirby S. Hays	CEO	15%
Jeff Geist	President	20%
Lori McDaniel	Controller	10%
Matt Goddard	Corporate Scheduler	20%
Tom Bailey	Operations Manager	33%
Jerry Neuman	General Superintendent	25%
Tom Lancaster	Corporate Safety Manager	20%
Jason Flowers	Corporate Quality Control Manager	20%



In addition to the corporate individuals in office whom guarantee their involvement throughout this project, **HHCI will provide quality team members** who will be working directly on the Fitch Park ASR Wells 5 & 6 Above Ground Facilities. The Project Manager and Superintendent will serve as the point of contact throughout the project's duration and will be at the jobsite at all times during construction. For those involved, an organizational chart is provided in order to indicate which the type of schedule an individual will have, in addition to where their work will take place:

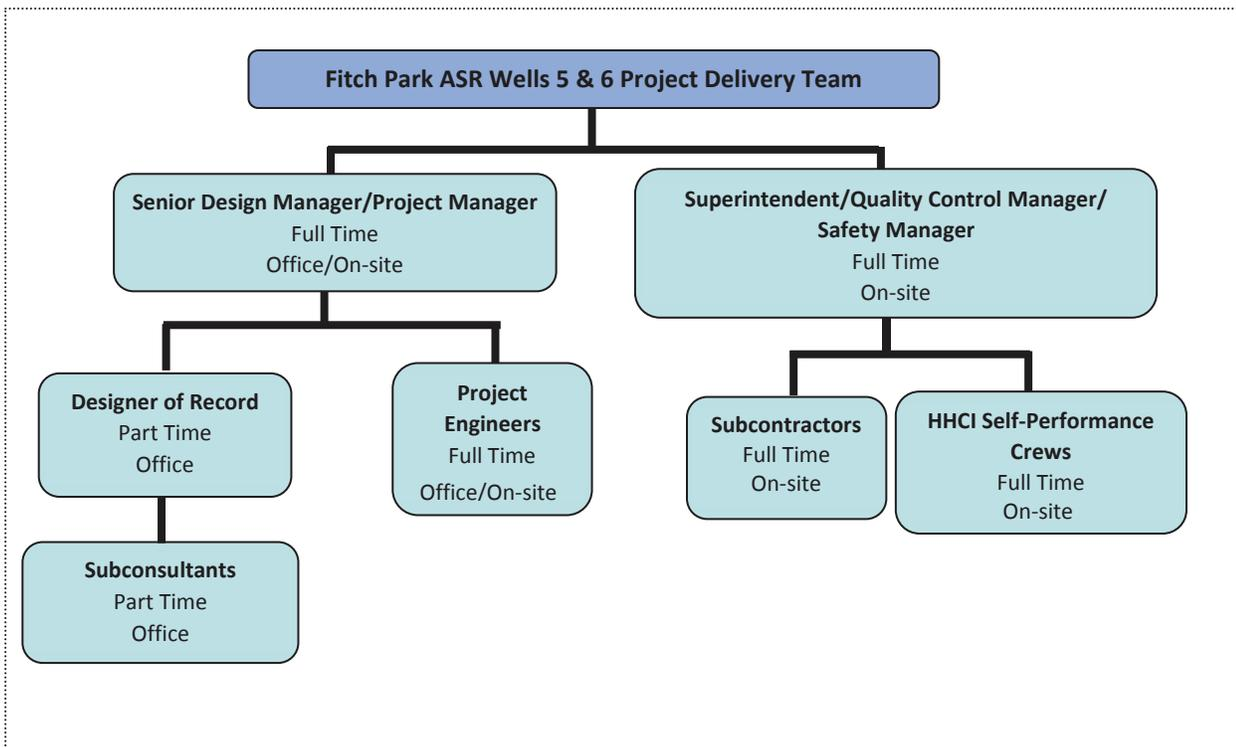

6. Provide a narrative description of the Design/Builder's understanding of the design concept for this facility. If the Design/Builder chooses to modify the proposed site layout included with the RFP, a drawing shall be provided to identify the proposed alternate layout. Additionally, provide specifics of any alternative design concepts, which may be proposed by the Design/Builder. The Design/Builder is encouraged to submit alternative design concepts, however, a proposal based on the defined design concept is mandatory. Should alternative proposals be submitted, preliminary sketches of the proposed facilities shall be included along with relative design and construction cost estimates comparing the alternative designs with that defined in this document.

HHCI understands this is a Design Build Project and will partner with LSCE, to develop preliminary and final designs of the facilities using the RFP to prepare plans, specifications and construction documents, and provide the necessary supervision, labor, materials, tools and equipment, on a Fixed Price Basis. HHCI and LSCE understands that CAWC is actively completing the Monterey Peninsula Water Supply Project (MPWSP), which involves **desalination of ocean water and storage and recovery of treated water supplies through an Aquifer Storage and Recovery (ASR) well field**. This project is focused on the completion of the above ground facilities for two new wells ASR-5 and ASR-6. As a separate project, CAWC is embarking on the production well construction and pump installation for ASR-5 and ASR-6. In addition, our team understands that the following is to be completed by others: ASR Well backflushing of up to 3,000 gpm for periodic flushing of the well via connection to a new waste pipeline installed in the GJM Blvd corridor by others, which terminates at the backflush/percolation pit at the existing Santa Margarita ASR Facility approximately 5,400 ft. south of 1910 GJM Blvd.

In preparation for bid and proposal development, HHCI's representative attended the site visit. Estimators have reviewed project plans, specifications, and subsequent amendments, conducted **6 proposal development strategy meetings** during which the team **evaluated design criteria** and project requirements, to devise **the safest, quality-oriented, sustainable and cost-conscious project solution** and sought clarifications from CAW to arrive at its proposal offering.

The project encompasses the following scope of work:

**Technical Approach of Major Project Tasks**

Task	Contributions of Various Disciplines Participating
<p><b>Design Group</b></p>	<p>HHCI has selected <b>LSCE</b> as the Designer and the Civil Engineer to the project delivery team. Based upon the firm's extensive design build experience as well as their successful work on other projects.</p> <p>LSCE has partnered with <b>Frisch Engineering, Inc.</b> to provide electrical engineering services and <b>William Merkel Associates Structural Engineering</b> to provide structural engineering services. In addition, LSCE will also be working with, <b>Silva Stowell Architects, LLP</b> as the architect for this project and <b>Vibro-Acoustic Consultants</b> as the acoustical engineer. HHCI has selected <b>Pacific Crest Engineering Inc.</b> to providing geotechnical testing, and <b>Rasmussen Land Surveying, Inc</b> as the surveyor for this project. For Control Integration and Programmer, HHCI has chosen <b>Telstar Instruments, Inc.</b></p>



<p><b>Design Phase</b> <b>Deliverables</b></p>	<p><b>Project Overview</b></p> <p>CAWC has elected to implement this project as a design-build for cost and schedule savings. The RFP included preliminary designs and sizing information based on assumptions of ASR well operation and capacity. The Design-Build team will evaluate and assess the validity and accuracy of the preliminary design information, which will be initiated through a critique of the preliminary design as stated in the Scope of Design Services.</p> <p><b>The design will include a design basis, detailed drawings and specifications (15%, 30%, 60%, 90% and 100%),</b> and functional description of facility. The design must incorporate CAWC’s standard design practices and standard materials/manufacturers. The Design-Build team will be responsible for permitting, construction, startup and commissioning of the facilities once there is an approved design and a Target Cost for construction, as delineated in the RFP. There will be meetings with the Owner and Contractor after each design deliverable and meetings to assess Value Engineering.</p> <p>The design of the ASR facilities includes the items specified in the RFP Technical Requirements for Project. The narrative below provides an overview of critical design features and further design considerations and alternatives that are part of LSCE’s approach to the ASR facilities.</p> <p><b>ASR Well Operation</b></p> <p>Each ASR well facility is anticipated to have an extraction rate of 3,000 gpm and an injection rate of 1,500 gpm. Based on the preliminary design information in RFP, it is anticipated that each vertical turbine lineshaft pump will have an 800-horsepower hollow shaft motor with a pump design point of 3,000 gpm at 792-feet total dynamic head. The pump components, motor, and downhole flow control valve will be designed and installed under a separate contract with CAWC’s well driller/consultant (Pueblo Water Resources). The final horsepower requirement for the motor will dictate the electrical service and sizing, which will be determined after the wells are installed and tested.</p> <p>Use of an ASR well involves injection water in suitable aquifer materials for storage during times when water is available, and recovery of the water from the aquifer when it is needed. ASR facilities are tied to the various modes of ASR operation, which include:</p> <ul style="list-style-type: none"> <li>▪ Recovery Mode, where water from the aquifer is pumped into the CAWC transmission main system under normal production;</li> <li>▪ Injection Mode, or aquifer Recharge, where water from the CAWC transmission main is injected into the well with the use of instrumentation and a downhole flow control valve;</li> <li>▪ Backflush Mode and Pump-to-Waste, which occurs at regular intervals during injection periods to flush accumulated particulates in the well, and during normal well on/off sequences to transition flow to/from the system to reduce water hammer;</li> <li>▪ Storage Mode either with or without Trickling Flow, which is where no pumping or injection is occurring except a stream of chlorinated water to limit</li> </ul>
--	---



biofouling. This mode was not specified in the RFP; however, chemical tubing can be added to the wellhead if desired for this function.

### **Process and Instrumentation Diagram (P&ID)**

The design of the new ASR wells will utilize the preliminary P&IDs provided in the RFP to be consistent with existing ASR wells operation. The two ASR wells will include modulating valves, open/close control valves and Variable Frequency Drives (VFD) for control of the modes of operation (Recovery, Injection, Backflush), as briefly discussed below.

*Recovery Mode* is controlled from a Variable Frequency Drive (VFD) for the 800 HP well pump and motor. During Recovery mode the injection Cla-Val remains closed and the VFD maintains desired flow rate setpoint to accommodate fluctuating water levels due to well clogging or variations in aquifer groundwater levels. The downhole water level transducer monitors levels and interlocks the well pump on low level setting. A filtered water pre-lubrication system will provide sufficient flow to the enclosed lineshaft assembly with a flow meter and alarm as specified.

*Injection Mode* is controlled from a Cal-Val series 131 Electronic Control Valve and the Baski downhole flow control valve with manual nitrogen gas control. The “injection” Cla-Val will open for injection and maintain constant downstream pressure to the well (as specified in the RFP). A Cal-Val control module VC-22D will be located next the wellhead with signal wires to the PLC to provide local and remote capability for open/close and pressure setpoint functions. During injection the Baski flow control valve will maintain desired flow setpoint while also maintaining sufficient upstream pressure to prevent cascading water in the well. LSCE will evaluate the use of the pressure reducing valve and upstream system pressure transducer monitoring to ensure sufficient distribution system pressure is maintained during injection.

*Backflush Mode* is controlled from a Cal-Val series 50-01 Pressure Relief and Pressure Sustaining Valve. The valve provides pressure relief to prevent overpressure from surge or loss of control. The “backflush” Cal-Val will have a solenoid override for open/close capability to engage Backflush mode and pump-to-waste functions. During Backflush mode, the Cla-Val opens and the VFD will maintain desired control of well flow and water levels. During normal well on/off sequences the valve will be used to transition water from the Cal-Am system to reduce water hammer.

Chlorine disinfection facilities will be located at ASR 5 site and will treated water from both ASR 5 and SR 6. To ensure that ASR 5 or 6 can be chlorinated independently, a dedicated supply line from ASR 6 must be routed to ASR 5 upstream of the chemical injector. The Conceptual Drawings for Proposal (enclosed) provide a piping arrangement to accomplish this. Water from ASR 6 is routed to the site from the Cal-



An Am Transmission main with a bypass valve. The ASR 6 Recovery and Injection modes can all route through the station at ASR 5. The Transmission main between ASR 5 and 6 will be non-chlorinated, which is why a normally closed bypass valve is provided in the Transmission main to isolate chlorinated/non-chlorinated sides. A P&ID was developed for the chemical disinfection system and piping alternation (enclosed).

### Chemical System

The ASR 5 site will include chemical disinfection facilities using 12.5% sodium hypochlorite. Chemical system will include a bulk storage tank, a day tank and transfer pump, two chemical metering pumps (for redundancy), two injectors (for redundancy), and a chlorine analyze sample line.

The chemical system will maintain a dosage rate into raw water through flow pacing and trimming on a feedback loop from chlorine analyzer residual concentrations. The flow pacing will allow chemical dosage to be set based on the variable flow of ASR 5 and ASR 6 combined or individual.

For bulk deliveries of sodium hypochlorite a tank inlet building connection and an air compressor will be designed to provide compressed air to the chemical delivery truck as needed to pressurize the truck and offload chemical. The bulk tank will be built with a sump (i.e. basement) sized to storage the entire tank contents for double containment.

The chemical system sizing, based on calculations conducted by LSCE, included:

- **Bulk Tank:** 4,600 gallons (33 days of storage with 15% safety factor)
- **2x Day Tanks:** 130 gallons (1-day storage based on 4,500 gpm flow of both wells combined)
- **2x Metering Pumps:** 130 gallons/day (based on 4,500 gpm flow of both wells)
- **2x Transfer Pumps:** 118 gallons/hour (to fill the Day Tank in one hour)
- **2x Chemical Injectors:** dual injectors provided (for redundancy) downstream of the ASR 5 check and the ASR 6 tee, to provide disinfection of both well water supplies.
- **Chlorine Analyzer:** an outdoor analyzer station constructed of NEMA 4X outdoor grade panels and includes a 3/8" sample tube in a 2" double containment pull conduit. The 0.5 gpm continuous sample stream to the chlorine analyzer will be drained in an onsite dry well (8 feet deep with perforated 6" pipe and filled with 1/2" gravel). Signal wiring will be directed to the PLC for control and monitoring.

### Buildings and Enclosures

The RFP Technical Requirements indicate there will be a building for the electrical/controls and chemical facilities, and a separate sound enclosure is required for the wells. The RFP indicates either combined or separate buildings can be provided for



electrical/controls and chemical facilities. The Architect subconsultant will provide massing studies, building elevations and designs to ensure conformance with the “Mediterranean” features desired by CAWC.

For the Design-Built proposal basis, below are the basic features of each buildings.

**#1 Electrical Control and Chemical Building (ASR 5 Site):**

- UBC Type U Classification
- 24’x54’ Floor Plan (Control Room is 380 sq. ft. interior; Chemical Room is 900 sq. ft interior).
- 13-foot tall walls.
- Non-combustible 8” thick CMU block construction.
- Concrete plank roofing, 24-ft long, 6” thick minimum, free spanning, pre-stressed, 40-inch wide panels (Spancrete or equal), sloped, with 2.5” poured concrete composite topping.
- Parapet 36” tall with 6” thick CMU, with single-ply cover or built-up tar cover on top.
- Copper rain gutter and flashing.
- Stucco plaster siding.
- Windows (1 per wall) 3’x4’, aluminum frame, 4-pane, double casement, wire glass (Mediterranean)
- Doors, insulated, wood 2.5” thick, fire rated, with wrought iron hardware (Mediterranean)
- Exterior lighting 12-foot spacing, typical.
- Flooring is 6” thick concrete slab with reinforcement and 18” x 18” footings.
- Chemical room has sump built into floor, 4-foot deep and 30-inch wide. *See M-2 Conceptual Drawing.*
- HVAC Systems:
  - Air Conditioning: roof-mounted unit, 64,000 BTU/Hr cooling capacity, 5-ton, with ducting to both rooms.
  - Control Room Ventilation: wall-mounted exhaust fan (Cook or equal); 1,000 CFM, with two (2) 24”x12” inlet louvers on double door.
  - Chemical Room Ventilation: floor-mounted exhaust blower (Hartzell or equal): 1,950 CFM, with three (3) 24”x12” inlet louvers on double door and single door.

**#2 Electrical Control Building (ASR 6 Site):**

- UBC Type U Classification
- 24’x16’ Floor Plan (Control Room is 380 sq. ft. interior).
- 13-foot tall walls.
- Non-combustible 8” thick CMU block construction.



- Concrete plank roofing, 24-ft long, 6” thick minimum, free spanning, pre-stressed, 40-inch wide panels (Spancrete or equal), sloped, with 2.5” poured concrete composite topping.
- Parapet 36” tall with 6” thick CMU, with single-ply cover or built-up tar cover on top.
- Copper rain gutter and flashing.
- Stucco plaster siding.
- Windows (1 per wall) 3’x4’, aluminum frame, 4-pane, double casement, wire glass (Mediterranean)
- Doors, insulated, wood 2.5” thick, fire rated, with wrought iron hardware (Mediterranean)
- Exterior lighting, 2 per wall minimum.
- Flooring is 6” thick concrete slab with reinforcement and 18” x 18” footings.
- HVAC Systems:
  - Air Conditioning: roof-mounted unit, 36,000 BTU/Hr cooling capacity, 3-ton.
  - Control Room Ventilation: wall-mounted exhaust fan (Cook or equal); 1,000 CFM, with two (2) 24”x12” inlet louvers on double door.

**#3 and #4 Well Sound Enclosure (ASR 5 and ASR 6 sites)**

The RFP and Addendum #4 indicate the well will have a “sound attenuating enclosure” with removable walls on three sides, with sound reduction from the 800 HP motor to meet the noise requirement of 60 dB at the property line. Addendum 4 indicates the well enclosure is not envisioned to be the same as the Control Building that is a CMU/Mediterranean building.

For the proposal, several sound enclosure alternatives were identified, below. The minimum size for a well enclosure is 15 feet x 15 feet horizontally to provide walk-around access, and 15 feet tall accounting for the 18-inch pump pedestal and 2 feet of clearance above the motor.

**Sound Study (Optional):** Due to the noise generated from the 800 HP variable speed motor and the proximity of residences, a sound study is recommended. LSCE has included a sound specialist (Acoustician) on the team to evaluate well enclosure design concepts and propose mitigations to the enclosure materials, openings, ventilation, etc., as necessary to meet the specified noise requirements. The Acoustician will develop a 3-D noise model of the well building based on inputs from LSCE’s Structural Engineer and Building Architect. An initial site ambient noise study will be conducted to assess baseline ambient noise generated from General Jim Moore Blvd. as an input to the model. Building design options will be assessed and any mitigations would be proposed. The cumulative effects of both ASR wells in operation will also be assessed. A report summarizing the evaluation will be included as part of the final Design Basis Memorandum in the 30% design



**Pre-engineered Fiberglass Sound Enclosure - Included in Proposal per RFP**

Custom pre-engineered sound enclosures are available complete with structural acoustical panels, hardware, wiring and ventilation. Two vendors that provide these types of packaged systems are: ENoise Control; and Acoustical Solutions. The acoustical panel enclosures are insulated double-wall construction with customized dimensions. Panels are factory assembled made from 16-gauge galvanized steel with mineral wool lining and insulated with sound-absorbing material that is inert, mildew-resistant, vermin-proof and incombustible. All wall panels are removeable (except for header panels and panels with ventilation hoods). Panels are secured to the frame from the outside of the enclosure with panel retainers and tongue and groove joints. All non-removeable panels are fixed and secured to the frame from the inside of the enclosure with sheet metal screws.

**(Optional Item A) Expand Building for Well in Lieu of Sound Enclosure \***

Given sound and aesthetic sensitivity of this project, the CMU Control Building can be expanded to provide an enclosure around the well, complete with the desired Mediterranean style finish. This option will provide maximum sound reduction and aesthetic qualities of the site. LSCE completed a similar building for Zone 7 Water Agency (see Mocho Wells 3 & 4 example in Figure 1 below). The Mocho Wells were each 600 HP ASR wells, enclosed in a building designed for sound mitigation and maintenance. The roof, doors and headers are completely removeable with the use of a crane or boom, resulting in total clear opening across the well for access with a fixed derrick drill rig.

For the Fitch Park ASR Wells 5 & 6 project, a similar building could be designed with architectural features such a tile roofing and ornamental wood-swing doors with wrought iron hardware. A third door could be added with a removable header to allow the three sides of access desired by CAWC. An optional design fee is included to expand the CMU well enclosure in the Design Scope and Fee that is proposed.

**\*The Optional Design Item A will be carried through the 30 Design.**

**Figure 1: Example of Removeable CMU Well Enclosure Integrated with Control Building**

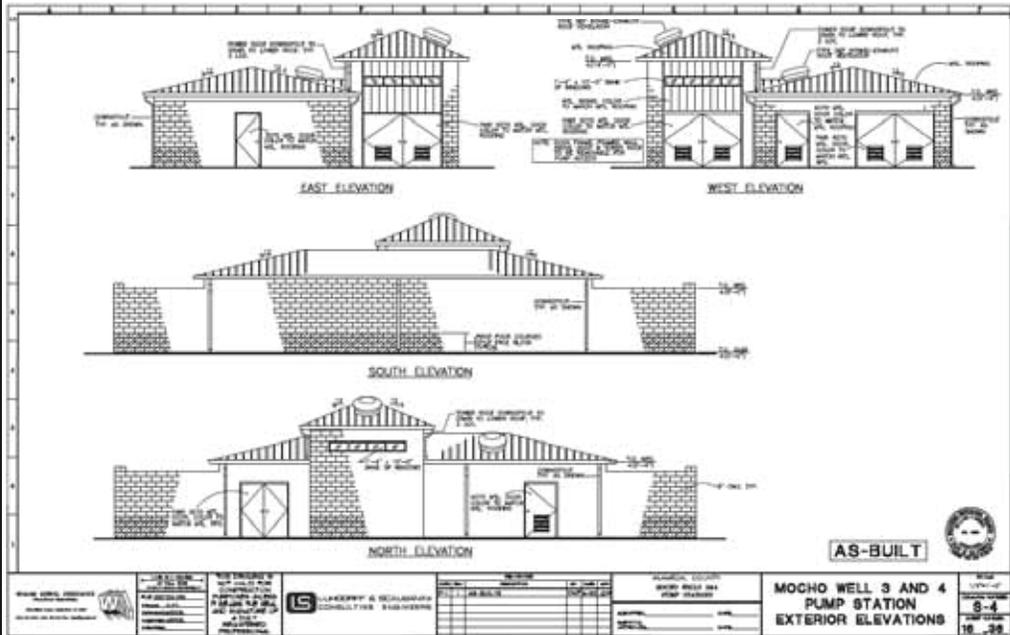

**Photo of Mocho ASR Building with CMU Enclosure**

Removeable roof and removeable doors and headers on both sides provide clear access across well for maintenance



**Optional Item B**

**Modify Fitch Park:**

- Architectural finish;
- 15-ft tall CMU Well Room;
- Removeable Tiled Roof;
- Removeable doors & headers;
- Match height of parapet over



**#6 (Optional Item B) Restroom Facility at ASR 5 site \*:** LSCE proposes to include a restroom/lavatory building design as an optional enhancement to the project. The operations personnel currently do not have access to a restroom in the local vicinity of the ASR wells. A restroom building would be situated as a standalone building on the ASR 5 site. This site was chosen because the site plan in the RFP shows a 10” sanitary sewer adjacent to the site. The lavatory would be located at least 50 feet from the well to meet the sanitary offset requirements in the DDW permitting/well siting. The lavatory would be detailed on the plans with building floor plan, foundation plan, elevations and related appliances and schedules. The scope includes obtaining a new sanitary sewer service connection from the sewer agency (Monterey Regional Water Pollution Control Agency) and a building permit.

For proposal purposes the “optional” restroom building would consist of:

- UBC Type U Classification
- 10’x10’ Floor Plan (100 sq. ft. interior).
- 10-foot tall walls.
- Non-combustible 8” thick CMU block construction.
- Roofing: hip roof with pre-engineered wood trusses and tile shingles (Mediterranean).
- Copper rain gutter and flashing.
- Stucco plaster siding.
- Windows (2 total) 3’x4’, aluminum frame, 4-pane, double casement, wire glass (Mediterranean)
- Doors, insulated, wood 1.75” thick, with wrought iron hardware (Mediterranean)
- Exterior lighting, 2 total.
- Ventilation: ceiling fan, 450 FM, with one (1) 24”x12” inlet louver on door.

**\*The Optional Design Item B will be carried through the 30% Design**

### **Conceptual Drawings for Proposal**

To provide further design details for the Design-Build proposal LSCE prepared a Conceptual Drawing Set that consist of: Site Plans (C-1, C-2 and C-3), Mechanical Station Pipe Plans (M-1), Chemical/Control Building Layout (M-2), and Disinfection P&ID (I-1). The RFP Preliminary Design Drawings in Appendix 1 of the Technical Requirements provide supplementary information for proposal purposes, which includes the: P&ID for ASR 5 & 6, Electrical One-Line Diagrams and Building Electrical Layout.

The conceptual site plan drawings developed for the Design-Build Proposal utilize the electronic site plans from the RFP, which were scanned PDF copies of a drawing. The scale was uncertain on the RFP site plans and the well and site boundaries were not dimensioned. Therefore, the conceptual drawing provided by LSCE for this proposal have approximate locations of wells and topographic features based on interpretation of



	the drawings in the RFP. The facility locations and layout are subject to change after final well siting by CAWC and its consultant and after the completion of a topographical basemap in AutoCAD.																																			
<b>Long Lead Items</b>	HHCI has identified the following <b>long lead items</b> : <ul style="list-style-type: none"> <li>▪ MCC – 8 weeks on submittal and 16 weeks on materials</li> <li>▪ VFD – 8 weeks on submittal and 24 weeks on driving</li> </ul> HHCI will prioritize <b>equipment review submittals</b> and <b>procurement tasks</b> for these items on the project schedule.																																			
<b>Equipment Manufacturer</b>	<table border="1"> <thead> <tr> <th data-bbox="425 709 922 764">ITEM DESCRIPTION</th> <th data-bbox="928 709 1425 764">PROPOSED</th> </tr> </thead> <tbody> <tr> <td colspan="2" data-bbox="425 764 1425 852"><i>Major Electrical Equipment Manufacturers</i></td> </tr> <tr> <td data-bbox="425 852 922 907">Motor Control Centers</td> <td data-bbox="928 852 1425 907">Eaton or Square D</td> </tr> <tr> <td data-bbox="425 907 922 961">Variable Frequency Drives</td> <td data-bbox="928 907 1425 961">Allen Bradley/Rockwell, Schneider</td> </tr> <tr> <td data-bbox="425 961 922 1016">Programmable Logic Controllers</td> <td data-bbox="928 961 1425 1016">Allen Bradley CompactLogix L3</td> </tr> <tr> <td data-bbox="425 1016 922 1071">Human Machine Interface</td> <td data-bbox="928 1016 1425 1071">ICONICS Gen32</td> </tr> <tr> <td data-bbox="425 1071 922 1125">Panels</td> <td data-bbox="928 1071 1425 1125">Hoffman Engineering</td> </tr> <tr> <td data-bbox="425 1125 922 1222">Industrial Ethernet Switch - managed switch</td> <td data-bbox="928 1125 1425 1222">Stratix</td> </tr> <tr> <td colspan="2" data-bbox="425 1222 1425 1276"><i>Programmers</i></td> </tr> <tr> <td colspan="2" data-bbox="425 1276 1425 1360"><i>Instrumentation and Controls Manufacturers</i></td> </tr> <tr> <td data-bbox="425 1360 922 1457">Flowmeter (12” Backflush - propeller)</td> <td data-bbox="928 1360 1425 1457">McCrometer Water Specialties</td> </tr> <tr> <td data-bbox="425 1457 922 1541">Flowmeter (12” Injection/Recovery – mag)</td> <td data-bbox="928 1457 1425 1541">Sparling Tigermag or Endress and Hauser</td> </tr> <tr> <td data-bbox="425 1541 922 1596">Pressure Transmitter Switch</td> <td data-bbox="928 1541 1425 1596">Rosemount or Endress and Hauser</td> </tr> <tr> <td data-bbox="425 1596 922 1680">Pressure Switch (high-pressure shutoff)</td> <td data-bbox="928 1596 1425 1680">Ashcroft</td> </tr> <tr> <td data-bbox="425 1680 922 1734">Tank Level Sensors – Ultrasonic</td> <td data-bbox="928 1680 1425 1734">Siemens or Endress and Hauser</td> </tr> <tr> <td data-bbox="425 1734 922 1789">Chlorine Residual Analyzer</td> <td data-bbox="928 1734 1425 1789">ProMinent</td> </tr> <tr> <td data-bbox="425 1789 922 1843">pH Analyzer</td> <td data-bbox="928 1789 1425 1843">ProMinent</td> </tr> </tbody> </table>	ITEM DESCRIPTION	PROPOSED	<i>Major Electrical Equipment Manufacturers</i>		Motor Control Centers	Eaton or Square D	Variable Frequency Drives	Allen Bradley/Rockwell, Schneider	Programmable Logic Controllers	Allen Bradley CompactLogix L3	Human Machine Interface	ICONICS Gen32	Panels	Hoffman Engineering	Industrial Ethernet Switch - managed switch	Stratix	<i>Programmers</i>		<i>Instrumentation and Controls Manufacturers</i>		Flowmeter (12” Backflush - propeller)	McCrometer Water Specialties	Flowmeter (12” Injection/Recovery – mag)	Sparling Tigermag or Endress and Hauser	Pressure Transmitter Switch	Rosemount or Endress and Hauser	Pressure Switch (high-pressure shutoff)	Ashcroft	Tank Level Sensors – Ultrasonic	Siemens or Endress and Hauser	Chlorine Residual Analyzer	ProMinent	pH Analyzer	ProMinent	
ITEM DESCRIPTION	PROPOSED																																			
<i>Major Electrical Equipment Manufacturers</i>																																				
Motor Control Centers	Eaton or Square D																																			
Variable Frequency Drives	Allen Bradley/Rockwell, Schneider																																			
Programmable Logic Controllers	Allen Bradley CompactLogix L3																																			
Human Machine Interface	ICONICS Gen32																																			
Panels	Hoffman Engineering																																			
Industrial Ethernet Switch - managed switch	Stratix																																			
<i>Programmers</i>																																				
<i>Instrumentation and Controls Manufacturers</i>																																				
Flowmeter (12” Backflush - propeller)	McCrometer Water Specialties																																			
Flowmeter (12” Injection/Recovery – mag)	Sparling Tigermag or Endress and Hauser																																			
Pressure Transmitter Switch	Rosemount or Endress and Hauser																																			
Pressure Switch (high-pressure shutoff)	Ashcroft																																			
Tank Level Sensors – Ultrasonic	Siemens or Endress and Hauser																																			
Chlorine Residual Analyzer	ProMinent																																			
pH Analyzer	ProMinent																																			

# CALIFORNIA AMERICAN WATER

## FITCH PARK ASR WELLS 5 AND 6

### ABOVE GROUND FACILITIES

#### SEASIDE, CALIFORNIA

DECEMBER 2018



LOCATION MAP

### CONCEPTUAL DRAWING SET

THIS CONCEPTUAL DRAWING SET SUPPLEMENTS THE "PRELIMINARY DESIGN DRAWINGS" IN APPENDIX 1 OF THE TECHNICAL REQUIREMENTS, ATTACHMENT B OF THE REQUEST FOR PROPOSALS (RFP). THE DESIGN-BUILD PROPOSAL IS BASED ON THE PRELIMINARY DESIGN DRAWINGS FROM THE RFP AND THIS CONCEPTUAL DRAWING SET.

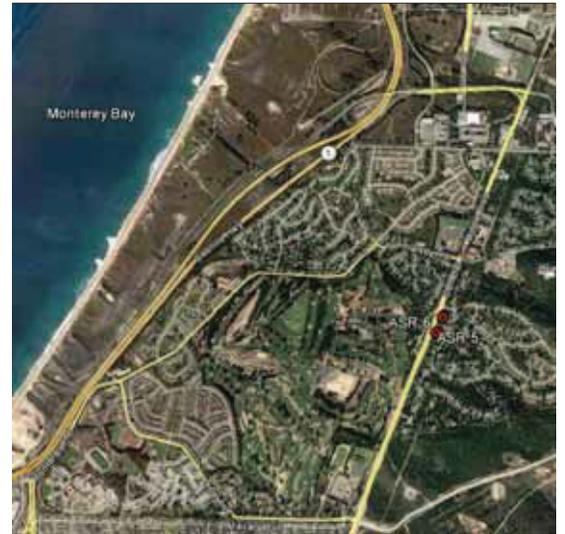

CAD FILE: C:\projects\ca-am\18-118\18-118-1.dwg DATE: 12/6/2018 2:21 PM

<b>DATE:</b> DECEMBER 2018 LINE IS 2 INCHES OF FULL SIZE IF NOT FULL SCALE ACCORDINGLY FILE: 18-118-1.dwg DRAWN: ABC/GBG DESIGNED: ABC CHECKED: ABC CHECKED:	<b>NOT FOR CONSTRUCTION FOR PROPOSAL ONLY</b>	 <b>Luhdorff &amp; Scalmanini</b> Consulting Engineers 500 First Street Woodland, California	<table border="1"> <thead> <tr> <th colspan="5">REVISIONS</th> </tr> <tr> <th>ZONE</th> <th>REV</th> <th>DESCRIPTION</th> <th>BY</th> <th>DATE</th> </tr> </thead> <tbody> <tr><td> </td><td> </td><td> </td><td> </td><td> </td></tr> <tr><td> </td><td> </td><td> </td><td> </td><td> </td></tr> <tr><td> </td><td> </td><td> </td><td> </td><td> </td></tr> <tr><td> </td><td> </td><td> </td><td> </td><td> </td></tr> <tr><td> </td><td> </td><td> </td><td> </td><td> </td></tr> </tbody> </table>	REVISIONS					ZONE	REV	DESCRIPTION	BY	DATE																										CALIFORNIA AMERICAN WATER <b>FITCH PARK ASR WELLS 5 AND 6</b> <b>ABOVE GROUND FACILITIES</b> SUBMITTED: _____ DATE: _____ SUBMITAL APPROVED: _____ DATE: _____	<b>TITLE SHEET</b> <b>LOCATION AND VICINITY MAPS</b>	SCALE: NO SCALE DRAWING NUMBER: <b>G-1</b> SHEET NUMBER: <b>1 of 7</b>
REVISIONS																																									
ZONE	REV	DESCRIPTION	BY	DATE																																					

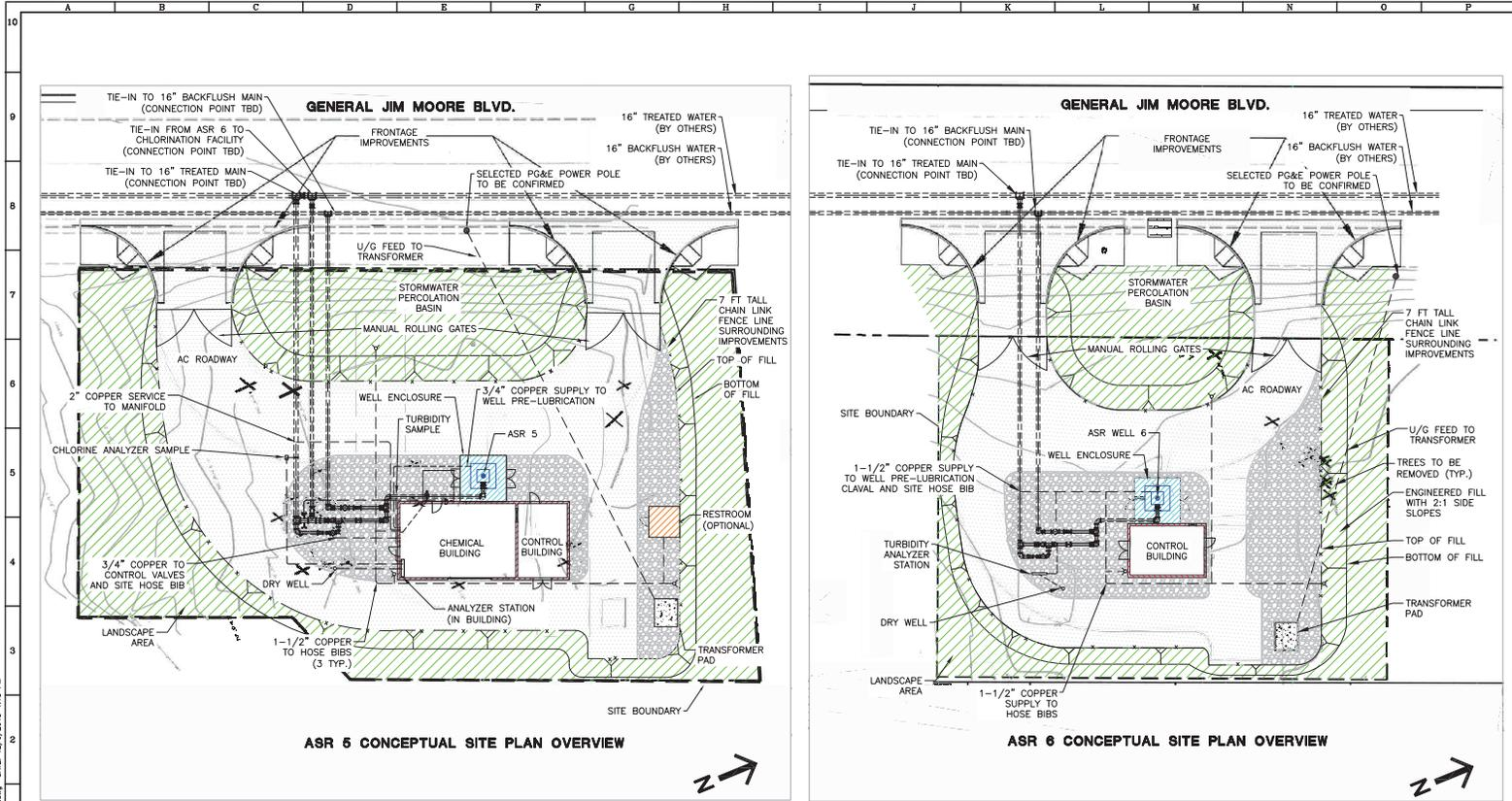

ASR 5 CONCEPTUAL SITE PLAN OVERVIEW

ASR 6 CONCEPTUAL SITE PLAN OVERVIEW

Scale in Feet  
0 7.5 15 30

DATE: DECEMBER 2018

LINE IS 2 INCHES  
OF FULL SIZE  
(IF NOT FULL SCALE ACCORDING)

FILE: C-1.DWG  
DRAWN: ABC/GBG  
DESIGNED: ABC  
CHECKED: MAG  
CHECKED:

**NOT FOR  
CONSTRUCTION  
FOR  
PROPOSAL  
ONLY**



ZONE	REV.	DESCRIPTION	BY	DATE	APP.

CALIFORNIA AMERICAN WATER  
FITCH PARK ASR WELLS 5 AND 6  
ABOVE GROUND FACILITIES

SUBMITTED: \_\_\_\_\_ DATE: \_\_\_\_\_  
SUBMITAL APPROVED: \_\_\_\_\_ DATE: \_\_\_\_\_

**OVERALL  
CONCEPTUAL  
SITE PLANS**

SCALE: AS SHOWN  
DRAWING NUMBER: **C-1**  
SHEET NUMBER: **2 of 7**

CAD FILE: Project-C:\w\18-3-18\C-1.DWG DATE: 12/6/2018 4:18 PM

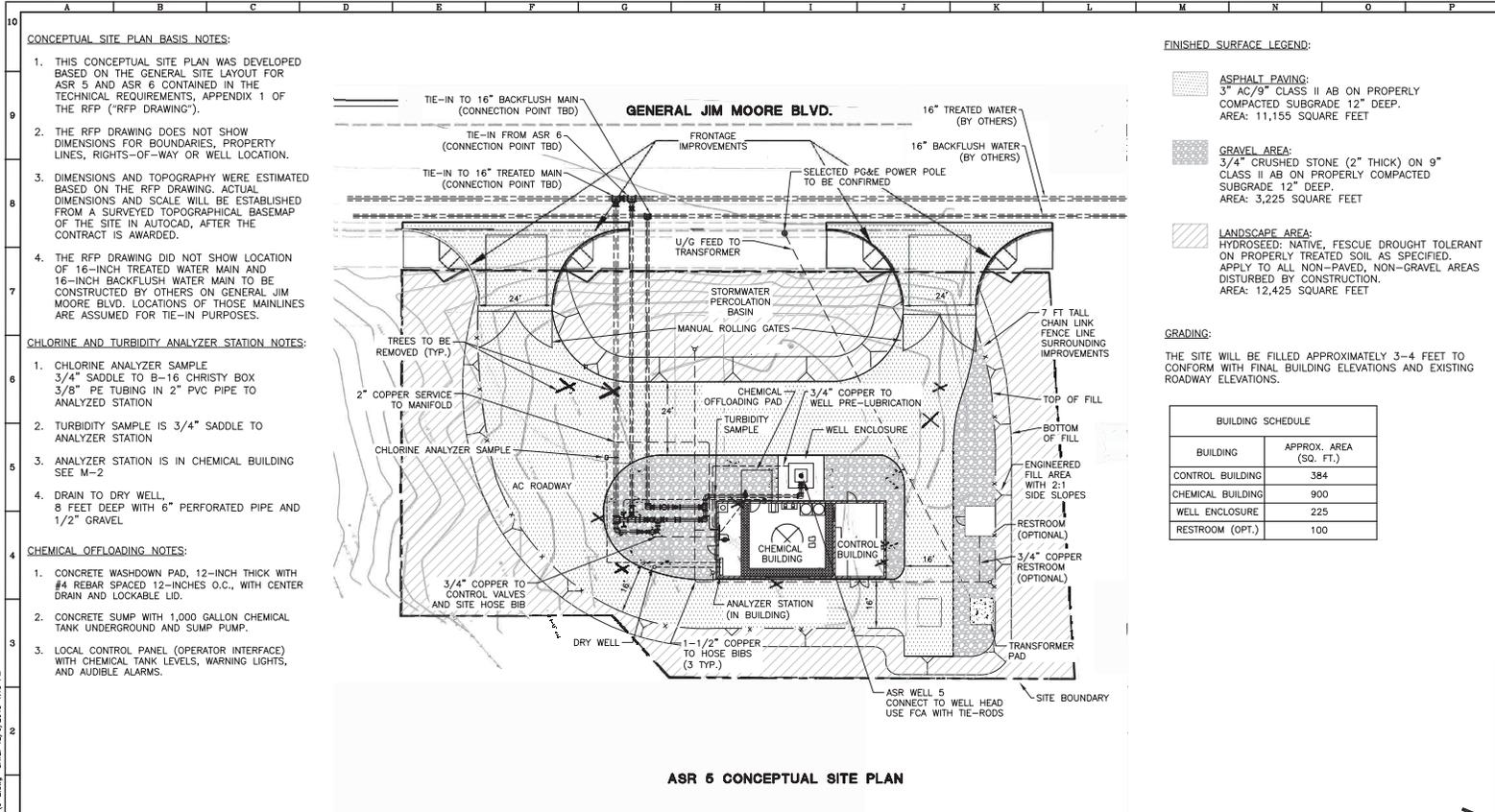

- CONCEPTUAL SITE PLAN BASIS NOTES:**
1. THIS CONCEPTUAL SITE PLAN WAS DEVELOPED BASED ON THE GENERAL SITE LAYOUT FOR ASR 5 AND ASR 6 CONTAINED IN THE TECHNICAL REQUIREMENTS, APPENDIX 1 OF THE RFP ("RFP DRAWING").
  2. THE RFP DRAWING DOES NOT SHOW DIMENSIONS FOR BOUNDARIES, PROPERTY LINES, RIGHTS-OF-WAY OR WELL LOCATION.
  3. DIMENSIONS AND TOPOGRAPHY WERE ESTIMATED BASED ON THE RFP DRAWING. ACTUAL DIMENSIONS AND SCALE WILL BE ESTABLISHED FROM A SURVEYED TOPOGRAPHICAL BASEMAP OF THE SITE IN AUTOCAD, AFTER THE CONTRACT IS AWARDED.
  4. THE RFP DRAWING DID NOT SHOW LOCATION OF 16-INCH TREATED WATER MAIN AND 16-INCH BACKFLUSH WATER MAIN TO BE CONSTRUCTED BY OTHERS ON GENERAL JIM MOORE BLVD. LOCATIONS OF THOSE MAINLINES ARE ASSUMED FOR TIE-IN PURPOSES.

- CHLORINE AND TURBIDITY ANALYZER STATION NOTES:**
1. CHLORINE ANALYZER SAMPLE 3/4" SADDLE TO B-16 CHRISTY BOX 3/8" PE TUBING IN 2" PVC PIPE TO ANALYZED STATION
  2. TURBIDITY SAMPLE IS 3/4" SADDLE TO ANALYZER STATION
  3. ANALYZER STATION IS IN CHEMICAL BUILDING SEE M-2
  4. DRAIN TO DRY WELL, 8 FEET DEEP WITH 6" PERFORATED PIPE AND 1/2" GRAVEL
- CHEMICAL OFFLOADING NOTES:**
1. CONCRETE WASHDOWN PAD, 12-INCH THICK WITH #4 REBAR SPACED 12-INCHES O.C., WITH CENTER DRAIN AND LOCKABLE LID.
  2. CONCRETE SUMP WITH 1,000 GALLON CHEMICAL TANK UNDERGROUND AND SUMP PUMP.
  3. LOCAL CONTROL PANEL (OPERATOR INTERFACE) WITH CHEMICAL TANK LEVELS, WARNING LIGHTS, AND AUDIBLE ALARMS.

- FINISHED SURFACE LEGEND:**
- ASPHALT PAVING:  
3" AC/9" CLASS II AB ON PROPERLY COMPACTED SUBGRADE 12" DEEP.  
AREA: 11,155 SQUARE FEET
  - GRAVEL AREA:  
3/4" CRUSHED STONE (2" THICK) ON 9" CLASS II AB ON PROPERLY COMPACTED SUBGRADE 12" DEEP.  
AREA: 3,225 SQUARE FEET
  - LANDSCAPE AREA:  
HYDROSEED: NATIVE, FESCUE DROUGHT TOLERANT ON PROPERLY TREATED SOIL AS SPECIFIED. APPLY TO ALL NON-PAVED, NON-GRAVEL AREAS DISTURBED BY CONSTRUCTION.  
AREA: 12,425 SQUARE FEET
- GRADING:**
- THE SITE WILL BE FILLED APPROXIMATELY 3-4 FEET TO CONFORM WITH FINAL BUILDING ELEVATIONS AND EXISTING ROADWAY ELEVATIONS.

BUILDING SCHEDULE	
BUILDING	APPROX. AREA (SQ. FT.)
CONTROL BUILDING	384
CHEMICAL BUILDING	900
WELL ENCLOSURE	225
RESTROOM (OPT.)	100

**ASR 5 CONCEPTUAL SITE PLAN**



CAD FILE: Project\ASR-5-1-18\C-2.dwg DATE: 12/6/2018 4:15 PM

<b>DATE:</b> DECEMBER 2018	LINE IS 2 INCHES OF FULL SIZE (IF NOT FULL SCALE OTHERWISE)
FILE: C-2.DWG	
DRAWN: ABC/GBG	
DESIGNED: JMS	
CHECKED: MMS	
CHECKED:	

**NOT FOR CONSTRUCTION FOR PROPOSAL ONLY**



REVISIONS				
ZONE	REV.	DESCRIPTION	BY	DATE

CALIFORNIA AMERICAN WATER  
FITCH PARK ASR WELLS 5 AND 6  
ABOVE GROUND FACILITIES

SUBMITTED: \_\_\_\_\_ DATE: \_\_\_\_\_  
SUBMITAL APPROVED: \_\_\_\_\_ DATE: \_\_\_\_\_

**ASR 5 CONCEPTUAL SITE PLAN**

SCALE: AS SHOWN  
DRAWING NUMBER: **C-2**  
SHEET NUMBER: **3 of 7**

A B C D E F G H I J K L M N O P

**CONCEPTUAL SITE PLAN BASIS NOTES:**

1. THIS CONCEPTUAL SITE PLAN WAS DEVELOPED BASED ON THE GENERAL SITE LAYOUT FOR ASR 5 AND ASR 6 CONTAINED IN THE TECHNICAL REQUIREMENTS, APPENDIX 1 OF THE RFP ("RFP DRAWING").
2. THE RFP DRAWING DOES NOT SHOW DIMENSIONS FOR BOUNDARIES, PROPERTY LINES, RIGHTS-OF-WAY OR WELL LOCATION.
3. DIMENSIONS AND TOPOGRAPHY WERE ESTIMATED BASED ON THE RFP DRAWING. ACTUAL DIMENSIONS AND SCALE WILL BE ESTABLISHED FROM A SURVEYED TOPOGRAPHICAL BASEMAP OF THE SITE IN AUTOCAD, AFTER THE CONTRACT IS AWARDED.
4. THE RFP DRAWING DID NOT SHOW LOCATION OF 16-INCH TREATED WATER MAIN AND 16-INCH BACKFLUSH WATER MAIN TO BE CONSTRUCTED BY OTHERS ON GENERAL JIM MOORE BLVD. LOCATIONS OF THOSE MAINLINES ARE ASSUMED FOR TIE-IN PURPOSES.

**TURBIDITY ANALYZER STATION NOTES:**

1. MOUNT TURBIDIMETER IN STAINLESS STEEL NEMA 4X BOX, LOCKABLE.
2. 1/4" ALUMINUM BACKBOARD, 20"W x 36"H SET ON 3" x 2" STEEL CHANNEL POSTS
3. DRAIN TO DRY WELL, 8 FEET DEEP WITH 6" PERFORATED PIPE AND 1/2" GRAVEL

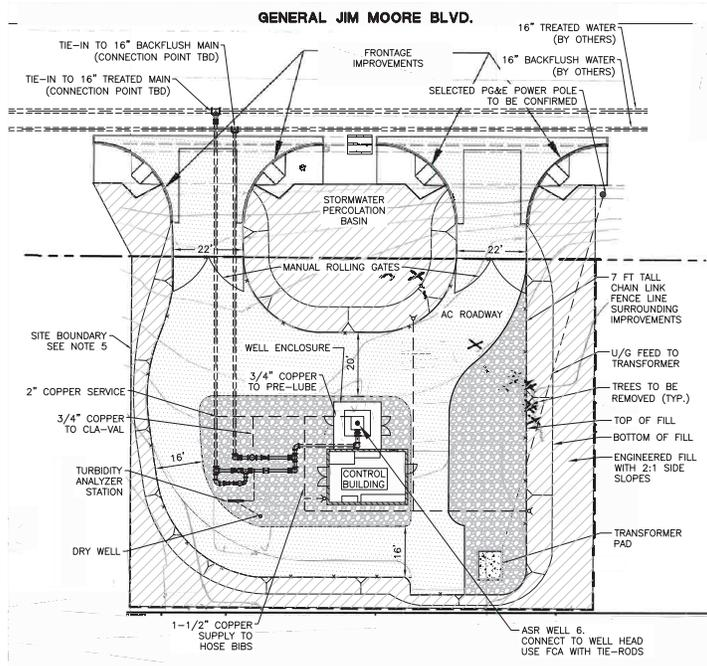

**ASR 6 CONCEPTUAL SITE PLAN**

**FINISHED SURFACE LEGEND:**

- ASPHALT PAVING:** 3" AC/9" CLASS II AB ON PROPERLY COMPACTED SUBGRADE 12" DEEP. AREA: 8,350 SQUARE FEET
- GRAVEL AREA:** 3/4" CRUSHED STONE (2" THICK) ON 9" CLASS II AB ON PROPERLY COMPACTED SUBGRADE 12" DEEP. AREA: 3,675 SQUARE FEET
- LANDSCAPE AREA:** HYDROSEED: NATIVE, FESCUE DROUGHT TOLERANT ON PROPERLY TREATED SOIL AS SPECIFIED. APPLY TO ALL NON-PAVED, NON-GRAVEL AREAS DISTURBED BY CONSTRUCTION. AREA: 8,065 SQUARE FEET

**GRADING:**

THE SITE WILL BE FILLED APPROXIMATELY 3-4 FEET TO CONFORM WITH FINAL BUILDING ELEVATIONS AND EXISTING ROADWAY ELEVATIONS.

BUILDING SCHEDULE	
BUILDING	APPROX. AREA (SQ. FT.)
CONTROL BUILDING	384
WELL ENCLOSURE	225

C:\P\Projects\ASR\ASR-1\ASR-1-10\ASR-1-10.dwg DATE: 12/6/2018 4:18 PM

<b>DATE:</b> DECEMBER 2018	LINE IS 2 INCHES OF FULL SIZE (IF NOT FULL SCALE OTHERWISE)
FILE: C-3.DWG	
DRAWN: ABC/GBG	
DESIGNED: JMS	
CHECKED: MBG	
CHECKED:	

**NOT FOR CONSTRUCTION FOR PROPOSAL ONLY**

**Luhdorff & Scalmanini**  
Consulting Engineers  
500 First Street  
Woodland, California

ZONE	REV.	DESCRIPTION	BY	DATE	APP.

CALIFORNIA AMERICAN WATER  
**FITCH PARK ASR WELLS 5 AND 6 ABOVE GROUND FACILITIES**

SUBMITTED: \_\_\_\_\_ DATE: \_\_\_\_\_  
SUBMITAL APPROVED: \_\_\_\_\_ DATE: \_\_\_\_\_

Scale in Feet  
0' 7.5' 15' 30'

**ASR 6 CONCEPTUAL SITE PLAN**

SCALE AS SHOWN  
DRAWING NUMBER **C-3**  
SHEET NUMBER **4 of 7**

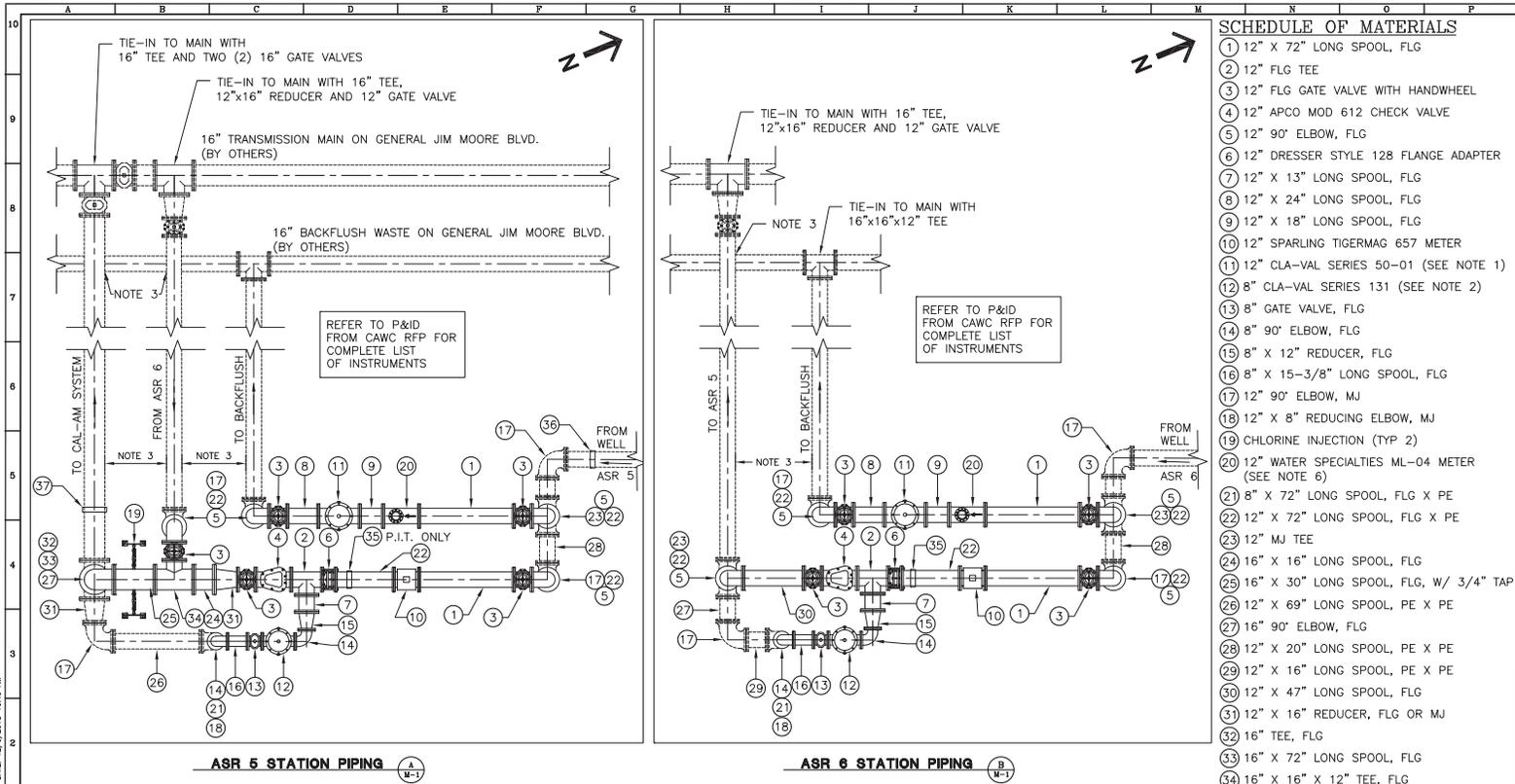

SCHEDULE OF MATERIALS	
①	12" X 72" LONG SPOOL, FLG
②	12" FLG TEE
③	12" FLG GATE VALVE WITH HANDWHEEL
④	12" APCO MOD 612 CHECK VALVE
⑤	12" 90° ELBOW, FLG
⑥	12" DRESSER STYLE 128 FLANGE ADAPTER
⑦	12" X 13" LONG SPOOL, FLG
⑧	12" X 24" LONG SPOOL, FLG
⑨	12" X 18" LONG SPOOL, FLG
⑩	12" SPARKLING TIGERMAG 657 METER
⑪	12" CLA-VAL SERIES 50-01 (SEE NOTE 1)
⑫	8" CLA-VAL SERIES 131 (SEE NOTE 2)
⑬	8" GATE VALVE, FLG
⑭	8" 90° ELBOW, FLG
⑮	8" X 12" REDUCER, FLG
⑯	8" X 15-3/8" LONG SPOOL, FLG
⑰	12" 90° ELBOW, MJ
⑱	12" X 8" REDUCING ELBOW, MJ
⑲	CHLORINE INJECTION (TYP 2)
⑳	12" WATER SPECIALTIES ML-04 METER (SEE NOTE 6)
㉑	8" X 72" LONG SPOOL, FLG X PE
㉒	12" X 72" LONG SPOOL, FLG X PE
㉓	12" MJ TEE
㉔	16" X 16" LONG SPOOL, FLG
㉕	16" X 30" LONG SPOOL, FLG, W/ 3/4" TAP
㉖	12" X 69" LONG SPOOL, PE X PE
㉗	16" 90° ELBOW, FLG
㉘	12" X 20" LONG SPOOL, PE X PE
㉙	12" X 16" LONG SPOOL, PE X PE
㉚	12" X 47" LONG SPOOL, FLG
㉛	12" X 16" REDUCER, FLG OR MJ
㉜	16" TEE, FLG
㉝	16" X 72" LONG SPOOL, FLG
㉞	16" X 16" X 12" TEE, FLG
㉟	2" TAP WITH P.I.T. AND TURBIDITY SAMPLE
㊱	3/4" SADDLE FOR TURBIDITY SAMPLE
㊲	3/4" SADDLE TO B-16 CHRISTY BOX FOR CHLORINE SAMPLE

**NOTES:**

- 12" CLA-VAL SERIES 50-01 W/120V SOLENOID W/ MANUAL OPERATOR, GLOBE STYLE, EPOXY LINED, STAINLESS STEEL TRIM, CHECK FEATURES, PILOT BALL VALVES, OPENING SPEED CONTROL
- 8" CLA-VAL SERIES 131 W/120V SOLENOID W/ MANUAL OPERATOR, GLOBE STYLE, EPOXY LINED, STAINLESS STEEL TRIM, CHECK FEATURES, PILOT BALL VALVES, OPENING AND CLOSING SPEED CONTROL
- TREATED WATER SHALL BE AT LEAST 1-FOOT VERTICALLY ABOVE AND 4 FEET HORIZONTALLY FROM ALL WATER AND BACKFLUSH WASTE (NON-POTABLE) IN ACCORDANCE WITH TITLE 22.
- ABOVE GROUND PIPE SHALL BE DIP WITH FUSION BOND EPOXY LINE AND COATING.
- BELOW GROUND PIPE SHALL BE DIP CEMENT LINED AND BITUMASTIC COATED.
- WATER SPECIALTIES ML-04 METER, 12" SIZE, INDICATOR & TOTALIZER IN GALLONS, STANDARD VELOCITY CONSTRUCTION

DATE: DECEMBER 2018	LINE IS 2 INCHES OR SMALLER (IF NOT F-SHAPE OTHERWISE)
FILE: M-1.DWG	<b>NOT FOR CONSTRUCTION FOR PROPOSAL ONLY</b>
DRAWN: ABC/GBG	
DESIGNED: ABC	
CHECKED: ABC	

**Luhdorff & Scalmanini**  
Consulting Engineers  
500 First Street  
Woodland, California

ZONE	REV	DESCRIPTION	BY	DATE	APP.

CALIFORNIA AMERICAN WATER  
FITCH PARK ASR WELLS 5 AND 6  
ABOVE GROUND FACILITIES

SUBMITTED: \_\_\_\_\_ DATE: \_\_\_\_\_  
APPROVED: \_\_\_\_\_ DATE: \_\_\_\_\_

<b>PIPING PLAN</b>	SCALE: 1"=6'
	DRAWING NUMBER: M-1
	SHEET NUMBER: 5 of 7

CAD FILE: P:\projects\2018\18-113\W-1.dwg DATE: 12/6/2018 10:48 AM

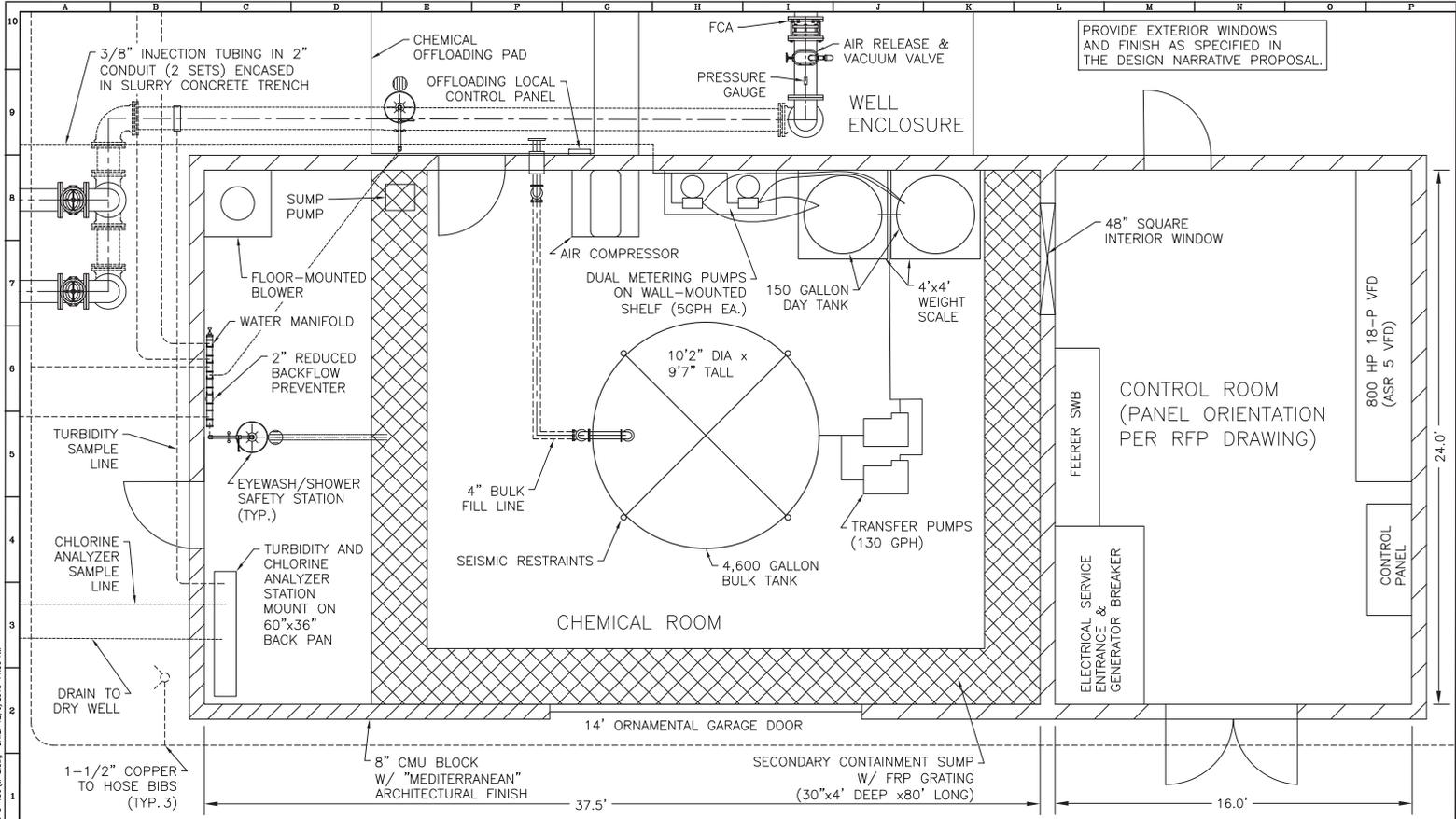

CAD FILE: Project\CA-18-1-18\M-2.dwg DATE: 12/6/2018 11:38 AM

**DATE:** DECEMBER 2018  
 LINE IS 2 INCHES  
 OR FULL SIZE  
 (IF NOT FULL SIZE, INDICATE)  
 FILE: M-2.DWG  
 DRAWN: ABC/GBG  
 DESIGNED: JMS  
 CHECKED: MBS  
 CHECKED:

**NOT FOR CONSTRUCTION FOR PROPOSAL ONLY**



ZONE	REV	DESCRIPTION	BY	DATE	APP.

CALIFORNIA AMERICAN WATER  
**FITCH PARK ASR WELLS 5 AND 6 ABOVE GROUND FACILITIES**  
 SUBMITTED: \_\_\_\_\_ DATE: \_\_\_\_\_  
 SUBMITAL APPROVED: \_\_\_\_\_ DATE: \_\_\_\_\_

**CHEMICAL & ELECTRICAL BUILDING LAYOUT (ASR 5)**  
 SCALE: 1"=4'  
 DRAWING NUMBER: **M-2**  
 SHEET NUMBER: **6 of 7**

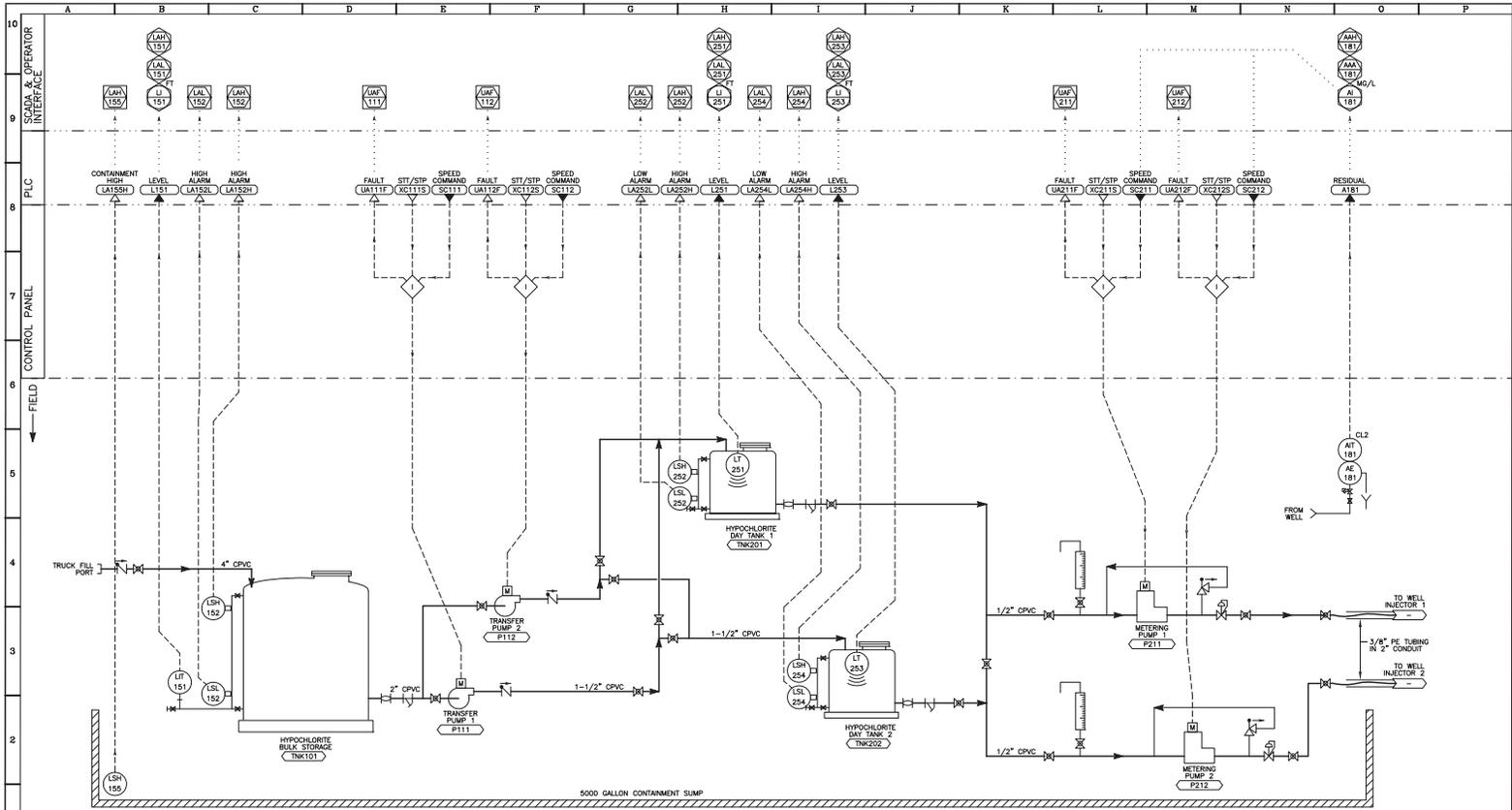

**SODIUM HYPOCHLORITE P&ID**

DATE: NOVEMBER 2018

LINE IS 2 INCHES  
AT FULL SIZE  
IF NO SCALE ACCORDING  
FILE Q-1.DWG.  
DRAWN: NIK  
DESIGNED: TFF  
CHECKED: TFF  
CHECKED:

NOT FOR  
CONSTRUCTION  
FOR  
PROPOSAL  
ONLY



REVISIONS				
ZONE	REV	DESCRIPTION	BY	DATE

CALIFORNIA AMERICAN WATER  
**FITCH PARK ASR WELLS 5 AND 6**  
ABOVE GROUND FACILITIES

SUBMITTED: \_\_\_\_\_ DATE: \_\_\_\_\_  
SUBMITAL APPROVED: \_\_\_\_\_ DATE: \_\_\_\_\_

INSTRUMENTATION  
HYPOCHLORITE SYSTEM  
P&ID

SCALE  
NO SCALE  
DRAWING NUMBER  
1-1  
SHEET NUMBER  
7 of 7



	Turbidimeter	Hach
	Level Switch - float	Siemens or Anchor Scientific or Connery
	Level Switch – Capacitive Proximity	Omron
	Flow Switch	Dwyer Instruments Inc.
	Submersible Well Level Transducer	Druck Model 1835 (550 feet cable)
	<b>SCADA Cellular Modem</b>	Sierra Wireless (GX450)
	<b>Chemical System</b>	
	Storage tanks	Poly Processing – (not double contained tank)
	Metering Pumps	ProMinent - Delta 0703
	Transfer Pump	ProMinent – Sigma 3
	Injector	ProMinent
	<b>Pipe and Valves</b>	
	Ductile Iron Pipe	US Pipe, CL350 (FEL&C above ground)
	Gate Valves	Clow, Mueller, Pratt, DeZurik
	Check Valves	Flomatic, Cla-Val, APCO
	Control Valves	Cla-Val (as specified on Drawings)
	<b>HVAC Equipment</b>	
	AC Units (roof mounted)	Rheem, Goodman
	Floor-mounted Blowers	Hartzell Fan
	Wall-mounted Exhaust Fan	Cook Fan
	Bathroom ceiling vent fan	Broan, Panasonic
<b>Project Critical Submittals</b>	Prior to mobilization and after final design approval, HHCI will submit for approval the list of <b>required submittals</b> as specified in the RFP: <ul style="list-style-type: none"> <li>▪ Alarm response list</li> <li>▪ Report to Assess Validity, Evaluate, Analyze Accuracy of Preliminary Design</li> <li>▪ Brass tag samples, size 1” x 2”, for equipment, with mechanical fastener samples</li> <li>▪ Bill of Materials, &amp; Fabrication Drawings</li> <li>▪ Building Code Review (part of design basis memorandum)</li> <li>▪ Color selections coatings, CMU, tiles, etc.</li> </ul>	



	<ul style="list-style-type: none"><li>▪ Certified calibrations for instruments, incl. flow meters</li><li>▪ Community outreach brochure</li><li>▪ Compaction tests of soils and engineering materials, soil sieve analysis, single/double ring infiltrometer tests, etc.</li><li>▪ Concrete compressive tests</li><li>▪ Concrete mix design</li><li>▪ Drawings &amp; Details, Phase 1 Site civil, piping and valves</li><li>▪ Drawings &amp; Details Phase 2</li><li>▪ Equipment data sheet tables</li><li>▪ Equipment Jobsite Storage, Lube, &amp; Maintenance Requirement List (warranty item)</li><li>▪ Electrical panel elevations</li><li>▪ Equipment IOM Manuals</li><li>▪ Equipment Lubrication Recommended List</li><li>▪ Factory acceptance test plan and schedule</li><li>▪ HMI Screen Shots (4 weeks prior to the FAT)</li><li>▪ Hydrostatic pressure test results</li><li>▪ Hydraulic Profiles for initial and ultimate conditions</li><li>▪ Input/Output Lists for PLC, digital and analog signals</li><li>▪ Installation, Operation, and Maintenance manuals, and CD's</li><li>▪ ISA20 Instrument Specification forms: level, sure transmitters/gages, solenoids, flow meters, pH transmitters, chlorine residual analyzers, turbidity meters, pressure switches, pressure regulators, rotameters &amp; calibration columns, variable frequency drives</li><li>▪ Geotechnical Engineering Report, boring logs, and recommendations</li><li>▪ Lighting and Grounding plan, &amp; details</li><li>▪ Ladder logic diagrams</li><li>▪ Mobilization, Security Fencing, Access Plan</li><li>▪ MSDS</li><li>▪ Motor load list</li><li>▪ One-line Diagrams (single line diagrams)</li><li>▪ Permits, encroachment, building, storm water, others as required</li><li>▪ P &amp; ID with tag numbers for all devices/instruments, valves, motors, pumps, etc.</li><li>▪ Paint &amp; Coatings Matrix List</li><li>▪ Parts List, &amp; Spare Parts List</li><li>▪ Piping ,Fittings, Valves, Special fittings, Lay Drawings</li><li>▪ PLC programming documentation (4 weeks prior to FAT)</li><li>▪ PLC control panel layout drawings, interconnection drawings, loop drawings</li><li>▪ Power supply study, Arc Flash study, labeling</li><li>▪ Process functional design specification</li><li>▪ Pump curves Vertical Turbine Pumps, chemical feed pumps, booster pumps</li><li>▪ Pump Test Plan &amp; Performance Testing</li><li>▪ Product Information, catalog cuts for equipment &amp; instruments</li><li>▪ Quality Management Plan</li><li>▪ SCADA control panel elevations</li><li>▪ Schematics wiring diagrams, Variable frequency drives etc.</li></ul>
--	--



- Startup & Operations Maintenance list for equipment
- Special Piping system drawings, and materials list (double containment pipe for chemicals)
- Start-Up & Commissioning Procedures Plan
- Symbols, drawings index, legends and abbreviations
- SWPPP, sediment and erosion control plan
- Samples of building materials
- Samples door, window hardware
- Samples, glass for window (12 in. square)
- Schedules, Gant, CPM, bar as required
- Staking/Surveying Plan, Mapping, & Implementation
- Technical Specifications (CSI format)
- Traffic control Plan
- Tags, equipment tag samples all panels, process piping, valves etc.
- Test reports for construction materials
- Utility Potholing & AutoCAD Mapping
- Valve list for control valves, isolation valves
- Vibration test report, 800 HP vertical turbine pumps
- Vibration detection system for the well pumps
- Warranty, 1 year limited, roofing materials
- Warranty, joint sealers
- Warranty, door hardware
- Warranty, protective coatings
- Warranty, equipment all types, 1-year warranty unless specified differently elsewhere
- Warranty, HVAC 2-year warrant
- Warranty, Variable Frequency Drive, 2-yr warranty all parts and labor from final acceptance
- Warranty, 800 HP well VTP (2 pumps), 2-yr warranty all parts and labor from final acceptance
- Warranty, protective circuits & motor relays, well pumps, 2-year warranty
- Warranty, control panels, 2-yr warranty
- Warranty, instruments, 1-yr warranty, except as indicated elsewhere
- Warranty, ductile iron pipe, 10-yr warranty
- Warranty, PLC, RTU, HMI hardware and software, 2-yr warranty
- Warranty, automatic transfer switches, 2-yr warranty
- Wire conduit and cable schedules
- Window and door schedules, and hardware
- Warranty bonds and service contracts

HHCI will review all submittals for **accuracy, completeness, and compliance with contract requirements via its quality control process**, and will indicate approvals on each submittal, as evidence of such coordination and review.



<p><b>Mobilization</b></p>	<p>After the award of the project and NTP, HHCI will start the process of materials' submittals and other required project requirements as follows:</p> <ul style="list-style-type: none"> <li>▪ Project Manager and Superintendent will visit the site to plan the lay down area requirements and storage area also to survey work area for access and limitations</li> <li>▪ HHCI will request a pre-construction meeting (kick-off meeting) to discuss <b>materials' submittals; CAW furnished materials, lay down area, jobsite requirements, contractor and subcontractor badging</b>, and other project requirements including jobsite security</li> <li>▪ Submit materials' submittals</li> <li>▪ Obtain necessary approvals.</li> <li>▪ Mobilization</li> <li>▪ Site Layout</li> <li>▪ Install Traffic Control Signs</li> <li>▪ Install BMPs / SWPPP Measures</li> </ul> <p><b>Self-Performance: HHCI to self-perform mobilization activities to assure <u>safe mitigation</u> of construction impacts on surrounding facilities/area.</b></p>
<p><b>Construction Phase</b></p>	<p>HHCI understands that the work approved in the construction documents is to be delivered with care and quality. Hal Hays Construction Inc., will perform the following <b>construction activities and phasing</b>, but is not limited to:</p> <p>During the construction, HHCI's Design-Build team, will conduct the following:</p> <ul style="list-style-type: none"> <li>▪ Bi-weekly meetings (24 total)</li> <li>▪ Design coordination</li> <li>▪ Review and approval of shop drawings and submittals</li> <li>▪ Design clarifications or supplemental design drawings</li> <li>▪ Factor Acceptance Testing (FAT) inspections</li> <li>▪ Startup phase services – Design Engineer and Specialty Engineers</li> <li>▪ Record Drawings</li> <li>▪ O&amp;M Manuals</li> <li>▪ 12-month anniversary inspection</li> <li>▪ (field inspections for milestone monitoring or code compliance were not requested in the RFP)</li> </ul> <p><b>Phase 1</b></p> <ul style="list-style-type: none"> <li>▪ Kick-off Meeting.</li> <li>▪ Equipment Mobilization.</li> <li>▪ Setup laydown area.</li> <li>▪ Install construction area signs.</li> <li>▪ Install BMPs as required.</li> <li>▪ Install Temporary Waterline.</li> <li>▪ Install temporary fence around perimeter of both sites.</li> <li>▪ Install Temporary Access for both sites including Construction Entrances.</li> </ul>



- Remover Trees at ASR 5 and 6 sites per plans.
- Do clearing & grubbing for both sites.
- Do Site Survey.
- Do initial rough grading and prepare the sites for well drilling contractor.
- Demobilize.

**Phase 2**

- Equipment Mobilization
- Clean site and prepare for second phase-2 grading
- Do Site Survey for Phase-2
- Do rough grading for phase-2
- Over-excavate for building pads
- Install Underground and aboveground Yard piping for both sites.
- Install Instrumentation.
- Perform Pressure/Disinfections tests.
- Connect Yard Piping to main lines at GJM Blvd.
- Install site electrical and lighting.
- Install site drainage/Sanitary Sewer/Water Line.
- Install all electrical conduits and cables.
- Excavate for Concrete Footings
- Install Rebar at Footings
- Inspection of Rebar Footings
- Pour Concrete Footings
- Rough-In Underground Electrical / Plumbing
- Form / Rebar Building Slab on Grade
- Inspection of Rebar Slab on Grade
- Pour Concrete Slab on Grade
- Cure Slab on Grade
- Install Pre-Fabricated Sound Enclosures
  - HHCI has plenty of experience with installation of well pump enclosures, per Appendix B, you will find the product data of the proposed Sound Enclosure. This is one of many options HHCI has determined suitable for the project. HHCI will collaborate with Cal American Water during the design to determine the best suitable Well Pump Sound Enclosure which will best meet the client's needs.
- Install Masonry Walls
- Inspection of Masonry Walls
- Install Door Frames
- Install Windows
- Install Concrete Roof Panels
- Install Stucco
- Install Roll-Up Door
- Install Roofing
- Rough-In Electrical / HVAC
- Install Doors / Hardware



	<ul style="list-style-type: none"> <li>▪ Install FRP Grating</li> <li>▪ Install HVAC Equipment</li> <li>▪ Paint Exterior Building</li> <li>▪ Install Electrical Equipment</li> <li>▪ Install Fence and gates both sites.</li> <li>▪ Install Site Concrete</li> <li>▪ Install Site Asphalt and Pavement Marking.</li> <li>▪ Install Electrical Switchboard and panels</li> <li>▪ Install Chemical Feed System.</li> <li>▪ Install VFDs.</li> <li>▪ Install and program PLC.</li> <li>▪ Hydroseeding landscape areas for both sites.</li> <li>▪ Test all electrical/instrumentation equipment.</li> <li>▪ Perform operational start-up &amp; testing.</li> <li>▪ Do training class for CAW Operation’s personnel.</li> <li>▪ Demobilize.</li> </ul> <p>For detailed construction activities and phasing for each area please refer to the enclosed <b>CPM schedule</b> and <b>alternate CPM Schedule</b>.</p> <p><b>Self-Performance: HHCI to self-perform key areas (depending upon subcontractor price competitiveness) to assure the highest quality level.</b></p>
<p><b>Testing and Commissioning</b></p>	<p><b>Facility Performance Testing and Commissioning</b>                  Below are the major steps that would generally be required for commissioning:</p> <p><i><b>Preliminary Testing Requirements</b></i></p> <ul style="list-style-type: none"> <li>▪ Develop and approve the Testing &amp; Startup Plan (submittal)</li> <li>▪ Develop and approve field and factory testing forms for mechanical and electrical equipment and field walk throughs.</li> <li>▪ Coordinate all permitting and inspection requirements through startup, including:                         <ul style="list-style-type: none"> <li>○ DDW permitting checklist for Amended Water Supply Permit</li> <li>○ Building/Fire permit inspections</li> <li>○ New utility service connections and abandonments</li> <li>○ CAWC and Consultant inspections</li> </ul> </li> </ul> <p><i><b>Factory Acceptance Testing (FAT)</b></i></p> <ul style="list-style-type: none"> <li>▪ Conduct FAT of all Control Panels and VFDs at the panel manufacturer factory to obtain approval for delivery.</li> <li>▪ Prior to FAT the manufacturer conducts all fabrication, wiring, setup, programming, and quality control (e.g. loop testing and continuity).</li> <li>▪ At the FAT, the System Integrator conducts a thorough and complete witnessed test demonstrating functionality including:                         <ul style="list-style-type: none"> <li>○ Visual and mechanical tests</li> <li>○ Wiring tests to confirm control panel wiring</li> <li>○ MCC and Control Panel tests</li> <li>○ Logic Controller I/O point-to-point tests</li> </ul> </li> </ul>



	<ul style="list-style-type: none"><li>○ Simulated alarm tests</li><li>○ Simulated operational control tests</li><li>○ Failure tests for operating in abnormal conditions (unstructured tests)</li></ul> <p><b><i>Field Operational Acceptance Testing (OAT)</i></b></p> <ul style="list-style-type: none"><li>▪ Electrical Pre-Energization Testing<ul style="list-style-type: none"><li>○ Calibration of all field instrumentation</li><li>○ Visual and mechanical inspection tests</li><li>○ Wire insulation and continuity tests</li><li>○ Grounding tests</li><li>○ Panelboard / breaker tests</li><li>○ “Greentag” inspection for utility metering</li></ul></li><li>▪ Mechanical Pre-Operational Testing<ul style="list-style-type: none"><li>○ Preliminary walk-through to verify all instrumentation and piping as approved; verify building systems, site improvements, mechanical and electrical equipment.</li><li>○ Disinfection and flushing of all new facilities</li><li>○ Hydrostatic testing of mainlines</li><li>○ Well Pump and Motor Efficiency and Performance Testing (by Owner)</li><li>○ Chemical system verification (by manufacturer)</li><li>○ Water quality sampling (bacteriological)</li><li>○ Final Tie-in to system</li></ul></li><li>▪ Electrical Pre-Operational Tests<ul style="list-style-type: none"><li>○ MCC and Control Panel Field Testing</li><li>○ Harmonic measurement (for VFDs)</li><li>○ Instrumentation transmitters and switches calibration tests</li><li>○ PLC I/O point tests</li><li>○ Communication tests</li></ul></li><li>▪ Operational Tests<ul style="list-style-type: none"><li>○ Demonstration of complete operational system, in accordance with approved Functional Description.</li><li>○ Verify all functionality and alarms.</li><li>○ Develop Initial Punchlist</li></ul></li></ul> <p><b><i>10-Day Performance Testing</i></b></p> <ul style="list-style-type: none"><li>▪ Operate system in “Auto” for 10-days without failure or critical alarms.</li></ul> <p><b><i>Final walkthrough and punchlist at the end of the successful 10-day test</i></b></p>
--	--



<b>Close Out</b>	<p>For the close-out phase, HHCI will perform <b>final inspection, punch list, commissioning coordination, and demobilization.</b></p> <p>Final Close Out operations will include the following areas/documents:</p> <ul style="list-style-type: none"><li>▪ Four (4) hard copies and electronic copies on CD of O&amp;M Manuals</li><li>▪ Final Completion Paperwork</li><li>▪ Punch List</li><li>▪ Submittals</li><li>▪ Inspection Certificates</li><li>▪ As-Built Drawings &amp; Specs to include Red-Lines</li><li>▪ Warranties</li><li>▪ Operating &amp; Maintenance Data</li><li>▪ Accepted Shop Drawings &amp; Samples</li><li>▪ Other Modifications to Contract</li><li>▪ Field Test Records</li><li>▪ Demonstrations/Training</li><li>▪ Equipment Service &amp; Maintenance</li><li>▪ Project Record Documents</li><li>▪ Final Application for Payment</li></ul>
------------------	---

For successful execution of the **Fitch Park ASR Wells 5 & 6 Above Ground Facilities Design Build Project**, HHCI will employ its vast resources including:

- An experienced Project Delivery Team, specifically selected from over **182+ team members**, possessing relevant experience, especially in new building construction.
- Over **\$13.7M** in owned, operated, maintained, and CARB-compliant heavy equipment
- Multiple **in-house** crews, with current **safety protocol expertise**, and **safety training**.
- **Experienced, pre-qualified, and vetted** subcontractors and suppliers

The HHCI Project Delivery Team **stands ready to deliver** this complex and challenging project!



- 
7. *Prepare a construction cost estimate of the Work, which shall be broken down by major work item, organized by Construction Specification Institute (CSI) division and major process components. This estimate will be used by the Owner to evaluate Design/Builder's understanding of the project, evaluate budget and rate impacts.*

**Price Breakdown:** Please see **enclosed** breakdown:

**MONTEREY PENINSULA WATER SUPPLY PROJECT**  
**ASR 5 AND 6 - DESIGN BUILD**  
**ABOVE GROUND FACILITIES PROJECT**

10/20/2018  
 Rev. 0

BID ITEM	APPROX. QTY.	UNIT	DESCRIPTION WITH UNIT PRICE (PRICE IS INCLUSIVE OF ALL APPLICABLE TAXES, PROFIT, INSURANCE, BONDS AND OTHER OVERHEAD)	UNIT PRICE	TOTAL ITEM PRICE
<b><u>PREDESIGN/DESIGN SERVICES</u></b>					
1	1	ALLOW	Community Outreach	\$7,000.00	\$7,000.00
2	1	LS	Design Services (Part III. Scope of Design Services, SDS 1-10)	\$202,325.00	\$202,325.00
3	1	LS	Dust and Noise Control Plan & Implementation	\$14,120.00	\$14,120.00
4	1	LS	Building Code Review, Procedures & Plan	\$5,325.00	\$5,325.00
5	1	LS	Mobilization, Security Fencing, Access Plan	\$65,060.00	\$65,060.00
6	1	LS	Temporary Power Plan	\$3,200.00	\$3,200.00
7	1	LS	DUPLICATE- Mobilization, Security Fencing, Access Plan, etc.		\$0.00
8	1	LS	SWPPP/Erosion & Sediment Control Plan	\$22,215.00	\$22,215.00
9	1	LS	Environmental Requirements {Permits 2.7.3}	\$3,100.00	\$3,100.00
10	1	LS	AVETTA Certification (2.7.3)		\$0.00
11	1	LS	Utility Potholing & AutoCAD Mapping	\$5,000.00	\$5,000.00
12	1	LS	Staking/Surveying Plan, Mapping, & Implementation	\$35,000.00	\$35,000.00
13	1	LS	Geotechnical Investigations & Borings, Soils Report (2 Sites)	\$22,300.00	\$22,300.00
14	1	LS	Demolition of Existing Structure Plan	\$1,500.00	\$1,500.00
15	1	LS	Traffic Control Plans & Implementation	\$6,700.00	\$6,700.00
16	1	LS	Acceptance Testing Plan & Implementation(2.7.4)	\$2,000.00	\$2,000.00
17	1	LS	Quality Management Plan (Design & Construction, (2.7.5)	\$3,500.00	\$3,500.00
18	1	LS	Materials Testing Plan (e.g. Concrete & Soils)	\$67,110.00	\$67,110.00
19	1	LS	Pump Test Plan & Performance Testing	\$1,025.00	\$1,025.00
20	1	LS	DELETED PER ADDENDUM 4		\$0.00
21	1	LS	Inspection & Test Procedures & Plan	\$16,125.00	\$16,125.00
22	1	LS	Factory Acceptance Testing/Designer Inspections, (SDS-9)	\$12,805.00	\$12,805.00
23	1	LS	Operations & Maintenance Training (2.7.6)	\$4,000.00	\$4,000.00
24	1	LS	Installation Operation, & Maintenance Manual (IOM), Scanned pdf & CD,	\$1,100.00	\$1,100.00
25	1	LS	Start-Up & Commissioning Procedures Plan	\$11,625.00	\$11,625.00
26	1	LS	Facility/Utility Shut-Down Plan	\$2,010.00	\$2,010.00
27	1	LS	Warranty & Acceptance Test Plan	\$9,860.00	\$9,860.00
28	1	LS	CSI format Technical Specifications (16 Divisions)	\$58,650.00	\$58,650.00
29	1	LS	Assess Validity, Evaluate, Analyze Accuracy of Preliminary Design	\$16,320.00	\$16,320.00
30	1	LS	Architectural Drawings/Renderings for Agency Approvals	\$63,890.00	\$63,890.00
31	1	LS	Civil Drawings, Auto Cad, Full and Half-Sizes	\$52,100.00	\$52,100.00
32	1	LS	Mechanical Drawings, Auto Cad, Full and Half-Sizes	\$56,385.00	\$56,385.00
33	1	LS	Electrical & Drawings, Auto Cad, Full and Half-Sizes	\$99,280.00	\$99,280.00
34	1	LS	Plumbing Drawings, Auto Cad Full and Half-Sizes	\$9,450.00	\$9,450.00
35	1	LS	Instrument Drawings, Auto Cad Full and Half Sizes	\$39,350.00	\$39,350.00
36	1	LS	HVAC Drawings, Auto Cad, Full and Half Sizes	\$12,315.00	\$12,315.00

37	1	LS	Process (P& ID) Drawing Updates, Add Disinfection, Auto Cad, Full/Half Sizes	\$60,300.00	\$60,300.00
38	1	LS	As-Built Drawing & Conformed Drawings in Auto-CAD	\$42,950.00	\$42,950.00
<b><u>PROJECT MANAGEMENT/CONSTRUCTION MEETINGS/REVIEWS</u></b>					
39	1	LS	Design Meetings (10)	\$32,700.00	\$32,700.00
40	1	LS	Construction Meetings (24)	\$65,300.00	\$65,300.00
41	1	LS	Constructability Review (3)	\$9,415.00	\$9,415.00
42	1	LS	Value Engineering (3)	\$14,180.00	\$14,180.00
<b><u>PROCUREMENT/CONSTRUCTION</u></b>					
43	1	LS	Mobilization/demobilization, Phase 1	\$131,000.00	\$131,000.00
44	1	LS	Mobilization/demobilization, Phase 2	\$255,000.00	\$255,000.00
<b><u>CIVIL/MECHANICAL/PROCESS</u></b>					\$0.00
45	1	LS	Site Preparation for Phase 1 Well Drilling (2 Sites)	\$79,100.00	\$79,100.00
46	1	LS	Site Preparation, All other work, Phase 2	\$125,340.00	\$125,340.00
47	1	LS	On-Site Drainage Percolation System, Infiltration Tests	\$62,825.00	\$62,825.00
48	1	LS	AC Pavement and Subgrade (Tech, Req, Appendix 1)	\$193,740.00	\$193,740.00
49	1	LS	Site Access & Perimeter Chain Link Fencing, & 7 ft. height, Double Gates (both sites)	\$76,505.00	\$76,505.00
50	1	LS	ASR Underground Pipeline connections to General Jim Moore Blvd at ASR 5 and 6 (Sheet I-1, Appendix 1)	\$319,190.00	\$319,190.00
51	1	LS	ASR Above Ground Piping/Valves (Sheet I1 G1, M1 Appendix 1)	\$235,650.00	\$235,650.00
52	1	LS	Cla-Val Valves, remote controlled, fusion bonded epoxy coating in/out, 110V solenoid manual override, stainless steel trim, indicating limit switches, pilot strainer, open/close speeds, isolation cocks (Tech Req, G1, M1 Appendix 1)	\$119,830.00	\$119,830.00
53	1	LS	Flow meters, Sparling 656 Tigermag magnetic, local display plus remote transmission 4-20 mA output, polyurethane liner, bidirectional rate and bidirectional totalizing functions (Tech Req, Appendix 1)	\$61,080.00	\$61,080.00
54	2	EA	Pump water flush lube system, real time flow measurement and lube line differential pressure instrumentation, with interlock shutdown of well pump upon loss of low or pressure in lube line (Tech Req, Appendix 1)	\$20,680.00	\$41,360.00
55	1	LS	DUPLICATE - ASR Underground Pipeline connections to General Jim Moore Blvd at ASR 5 and 6 (Sheet I-1, Appendix 1)		\$0.00
56	1	LS	DUPLICATE - ASR Above Ground Piping/Valves (Sheet I1 G1, M1 Appendix 1)		\$0.00
57	1	LS	Isolation Valves, ( with manual operators larger than 8" diameter)	\$11,215.00	\$11,215.00
58	2	EA	DELETED PER ADDENDUM 4		\$0.00
59	2	EA	DELETED PER ADDENDUM 4		\$0.00
60	2	EA	DELETED PER ADDENDUM 4		\$0.00
61	1	LS	Complete Chemical Offloading Facility for bulk sodium hypochlorite deliver off-loading, with wash-down pad sized for WB-50/5,000 gallon storage tanker truck, local control panel, audible alarm, and warning lights, sump, and sump pump and underground chemical resistant storage tank 1000 gal., Compressed air supply to pressurize truck and offload chemical, Operator Interface Panel with level indicator for chemical level in bulk tank, safety showers (2), eyewash stations (2), chemical injecting quills, and injecting ports with static mixers for hypochlorite injection ( at ASR 5 SITE ONLY.)	\$29,560.00	\$29,560.00

62	1	LS	Complete Disinfection Process Facility for Sodium Hypochlorite system (12.5% solution strength), assume dosing up to 3 mg/l, storage of 30 days supply of bulk storage, FRP bulk storage tank, (2) day tank, (2) bulk transfer pumps, (2) chemical metering pumps, piping and valves, and ancillary equipment. Note a P & ID has not been completed. Contractor shall attach proposed P & ID with the bid for approval. Assume double containment for all chemical storage and dispensing equipment (at ASR 5 SITE ONLY).	\$134,525.00	\$134,525.00
----	---	----	---	--------------	--------------

**Structural/HVAC** \$0.00

63	1	LS	Complete ASR 6 Electric/Controls Bldg. 380 sq. ft. interior minimum, Removable Sound Attenuation Enclosure around pump, non-combustible CMU with Concrete Plank Roof, UBC Type U Building Classification, Mediterranean style, similar to ASR 3 & 4 (Appendix 1)	\$370,000.00	\$370,000.00
64	1	LS	Complete ASR 5 Electric/Controls Bldg. (min interior 350 sq. ft.) and Disinfection Bldg. (min. interior 650 sq. ft.) interior minimum, Sound Attenuation Enclosure around pump, non-combustible CMU with Concrete Plank Roof, UBC Type U Building Classification, Mediterranean style, similar to ASR 3 & 4 (Appendix 1)	\$676,980.00	\$676,980.00
65	2	EA	Complete HVAC, Air Conditioning with Economizer mode systems each for Electrical/control Building (Tech Req, Appendix 1)	\$46,160.00	\$92,320.00

**Electrical** \$0.00

66	1	LS	Complete Electrical Systems, for NEC calculated full-load amperage (FLA) of 1282 amperes, which includes pump, & misc. auxiliary loads, as shown in "Table MSB & Feeder Load Schedule" on Drawing E-1. Panels sizes for 1600-ampere meter/main	\$856,125.00	\$856,125.00
67	2	EA	Short Circuit and Arch Flash Studies, developed per Cal Am standards, and PGE system data (Appendix 1, 3, 4).Layout per Dwg E-2, Appendix 1.	\$10,200.00	\$20,400.00

**Instrumentation/Controls** \$0.00

68	2	EA	Complete control system, functionality including start, stop, speed control of the pumps, based on either flow or pressure set point, or manual adjustment. actuation of the Cla Val process valves, Alarm, warning and shutdown interlock functions, record and store process operational data, communicate with main Cal-Am SCADA system, PLC with 10% spare digital I/O, local control panel (LCP), (Tech Req, Drawing I-1, Appendix 1)	\$28,130.00	\$56,260.00
69	2	EA	Variable Frequency Drive (VFD), indoor NEMA 1G, 18 pulse PWM, No bypass, Heavy Duty Service (50 C rated), dv/dt output filter, Allen Bradley Power Flex 755	\$298,695.00	\$597,390.00
70	2	EA	Programmable Logic Controllers, Allen Bradley only. PLC program and OIP screens programmed to control the pumps and show booster and well pump operation, status, and alarms, indicated in Tech requirements and on P & ID, Appendix 1	\$31,085.00	\$62,170.00
71	2	EA	Data System to Transmit Data via SCADA to Cal Am's central Office in Pacific Grove via cellular modem.	\$18,880.00	\$37,760.00
72	2	EA	Local Operator Interface Panel (OIP), on front of each control panel. PLC program and OIP screens programmed to control the pumps and show booster and well pump operation, status, and alarms, indicated in Tech requirements and on P & ID, Appendix 1	\$14,270.00	\$28,540.00
73	1	LS	Differential Pressure Transmitters, and pressure transmitters, heat traced and mounted in O'Brien instrument enclosures All transmitter tubing shall be heat traced	\$32,340.00	\$32,340.00

<b>Subtotal</b>	<b>\$ 5,862,795</b>
<b>Contingency</b> 30%	<b>\$ 1,758,839</b>
	<b>\$ 7,621,634</b>

## OPTIONS

OPTION ITEM	APPROX. QTY.	UNIT	DESCRIPTION WITH UNIT PRICE (PRICE IS INCLUSIVE OF ALL APPLICABLE TAXES, PROFIT, INSURANCE, BONDS AND OTHER OVERHEAD)	UNIT PRICE	TOTAL ITEM PRICE
1	1	ALLOW	Restore concrete curb and gutter at bike path	\$8,000.00	\$8,000.00
2	1	LS	Construct 10x10 Restroom Building at ASR-5 Site	\$110,122.00	\$110,122.00
<b>Subtotal</b>					<b>\$ 118,122</b>

## VALUE ENGINEERING

VE ITEM	APPROX. QTY.	UNIT	DESCRIPTION WITH UNIT PRICE (PRICE IS INCLUSIVE OF ALL APPLICABLE TAXES, PROFIT, INSURANCE, BONDS AND OTHER OVERHEAD)	UNIT PRICE	TOTAL ITEM PRICE
1	1	LS	Deduct if able to remove 30% Design Deliverable (plans / specs) and meeting	-\$33,000.00	-\$33,000.00
2	1	LS	Deduct if able to reduce the number of Design Meetings from 10 to 5 meetings	-\$13,500.00	-\$13,500.00
3	1	LS	Deduct if able to reduce the number of Construction Meetings the Designer is required to attend from 24 to 12 meetings	-\$20,000.00	-\$20,000.00
4	1	LS	Deduct if able to reduce Electrical Engineer site visits during Start-up from 10 to 5 site visits	-\$9,500.00	-\$9,500.00
<b>Subtotal</b>					<b>\$ (76,000)</b>

8. *The anticipated number and depth of all soil borings, if any, required after award of contract.*

For the geotechnical, our subconsultant Pacific Crest Engineering Inc. will explore, sample and classify surface and subsurface soils by drilling **4-6 exploratory borings** across the project area. Using Cone Penetrometer Test (CPT) soundings and in conjunction with subsurface borings, they will be able to evaluate the density and strength characteristics of the soil profile to the depths explored and obtain samples at selected depths within planned foundation areas.

At least one boring in the proximity of the proposed Percolation Basin shall be drilled and converted to an infiltration test hole and tested for infiltration characteristics. We have assumed one day of testing to be performed in accordance with the “Native Soil Assessment for Small Infiltration Based Stormwater Control Measures” guidelines prepared by Earth Systems Pacific for the Central Coast Low Impact Development Initiative. **The anticipated test depth is expected to range from approximately 3 to 5 feet below bottom of design pond elevation.**

The exploratory borings/soundings will range in **depth from 10 to 20 feet**, however, at least one CPT sounding will be extended to a depth of 50 feet to quantitatively address liquefaction and/or dynamic compaction potential beneath the project site. Soil samples will be obtained at selected depths within selected test borings. The test borings will be backfilled with soil cuttings upon completion of drilling.

9. *Specifics of any exceptions, which are taken to items requested in this document. If no exceptions are taken, it is not necessary to reiterate the information in the Scope of Services Required.*

The following items represent **HHCI’s exceptions and clarifications:**

- Permit Fees will be reimbursed by the owner
- Handling and disposal of any Hazardous materials is not included
- Contractor furnish and installs: transformer pad, primary and secondary conduits, meter main switchboard.
- PG&E furnish and installs: transformer, primary/secondary wires, utility meter
- HHCI will include an allowance of \$20,000 for installation of piping and valves
- Per addendum 5 Section 4, the generator can be max 80 horsepower / 480 KV<sub>a</sub>
- Landscaping shall consist of hydroseed of the areas outside of pavement and building areas to restore all disturbed earth to healthy, native, drought tolerant vegetation. The hydroseed mix and supplier shall be approved by the Owner. The hydroseed mix will be a native, drought-tolerant variety that does not require permanent irrigation nor mowing after the fescue is properly established. The hydroseed shall be either Heritage Mix, Native Ornamental Fine Fescue Mix, or California Bay Area Wildflower Mix, or others if directed by the Owner. Installation of hydroseed shall be completed by a Licensed Landscape Contractor. Installation shall include: weed eradication of native soil six weeks and three weeks prior hydroseed planting – required watering and chemicals to kills weeds; soil preparation and amendment using fertilizers; application of hydroseed mix; temporary watering and weed removal for at least three months, or longer, to establish the seed mix.



10. *A listing of drawings and specifications required for this project, with titles for each drawing.*

The following items represent **HHCI's list of drawings and specifications**:

The construction drawings shall be in the latest version of AutoCAD and in PDF format.

- The specifications will be in Microsoft Word® and in PDF format and the design calculations will be in PDF format.
- The design will be in accordance with provisions of the latest **California Building Code**

**Listing of Technical Specifications (CSI Format):**

**Division 1 - General Requirements**

<b>Section</b>	<b>Description</b>
01100	Summary of Work/ General Requirements
01110	Codes and Permits
01200	Mobilization
01310	Progress Schedules
01320	Project Meetings
01330	Project Records and Submittals
01335	Site Health and Safety Plan
01420	Reference Standards and Abbreviations
01465	Equipment Testing & Startup
01555	Temporary Traffic Control
01565	Temporary Barrier Fencing
01575	Temporary Erosion Control
01600	Delivery, Storage and Handling
01730	Operation and Maintenance Data
01735	Training Requirements
01738	Warranties and Bonds
01750	Project Closeout

**Division 2 – Site Construction**

<b>Section</b>	<b>Description</b>
02235	Clearing and Grubbing
02300	Earthwork
02315	Trench Excavation and Backfill
02740	Asphalt Paving



---

02825	Site Security Fencing
02825	Landscape Planting
02952	Site Cleanup

### Division 3 – Concrete

Section	Description
03300	Concrete
03400	Precast Concrete
03600	Grout

### Division 4 – Masonry

Section	Description
04200	Concrete Masonry Units

### Division 5 – Metals

Section	Description
05120	Structural Steel
05210	Open Web Steel
05500	Metal Fabrications

### Division 6 – Wood and Plastics

Section	Description
06100	Rough Carpentry
06170	Prefabricated Wood Trusses
06175	Plywood Web Joists

### Division 7 – Thermal and Moisture Protection

Section	Description
07420	Roofing and Siding

### Division 8 – Openings

Section	Description
08110	Doors, Frames and Windows
08710	Finish Hardware



## Division 9 – Finishes

Section	Description
09900	Painting

## Division 10 – Specialties

Section	Description
10050	Building Miscellaneous
10440	Signs and Safety Equipment

## Division 11 – (Not Used)

## Division 12 – (Not Used)

## Division 13 – Special Construction

Section	Description
13224	Sodium Hypo Tank
13230	Chlorine Residual Analyzer
13420	process control instruments

## Division 14 – (Not Used)

## Division 15 – Mechanical

Section	Description
15025	Pipe (Station, Distribution, and Drainage)
15110	Valves and Related Appurtenances
15140	Chemical Feed Equipment
15145	Disinfection of Piping
15950	Performance Testing and commissioning

## Division 16 – Electrical

Section	Description
16110	Conduit and Boxes
16120	Low Voltage Wire and Data Cable



---

16430	Low Voltage Switchboard
16450	Grounding
16470	Panelboard and Power Transformer
16480	Motor Control Center
16481	Variable Frequency Drive
16600	Factory and Field Testing
16905	Control Panels
16910	PLC & OI Hardware
16915	PLC & OI Applications Programming
16933	Video Monitoring System
16940	Instrumentation

11. *A listing of all Federal, State, and local permits required for design, construction and operation of the proposed facility. Identify anticipated review time for each permit and any special requirement that may delay the process.*

### Listing of Permits and Outside Utility Approvals

- **Presidio of Monterey (8-week plan review)**
  - Fire Department - Fire protection and plan review
  - Building & Safety – building permit
  - Land Use Permit – building, landscaping, security fencing, architectural review
  - Site Grading and Civil Improvements
- **City of Seaside (6-week plan review)**
  - Encroachment Permit
    - (occurs during design, with inspection during construction)
- **Monterey Regional Water Pollution Control Agency (8-week plan review)**
  - New Sewer Service (optional)
    - (occurs during design, with inspection during construction)
- **Pacific Gas & Electric (10-week plan review and utility design)**
  - New Electrical Service Application
    - (occurs during design and coordinating with PG&E during construction for new transformer, primary/secondary conduits, and Green tag meter main).
- **State Water Resources Control Board, Division of Drinking Water (4-week plan review)**
  - Initial Well Siting Plan
  - Domestic Water Supply Permit Amendment for Cal-Am Water
    - (occurs before, during and after commissioning of the new facility. Includes a plan review, sanitary inspection and water quality testing prior to startup, and a final water source assessment, a technical report and as-builts after commissioning).

12. A project team organizational chart headed up by the proposed project manager and including all other engineering personnel from all disciplines who are expected to be directly associated with this project and construction supervision personnel.

Please refer to **Appendix A-2** for the necessary resumes

**Fitch Park ASR Wells 5 & 6 Project Delivery Team**

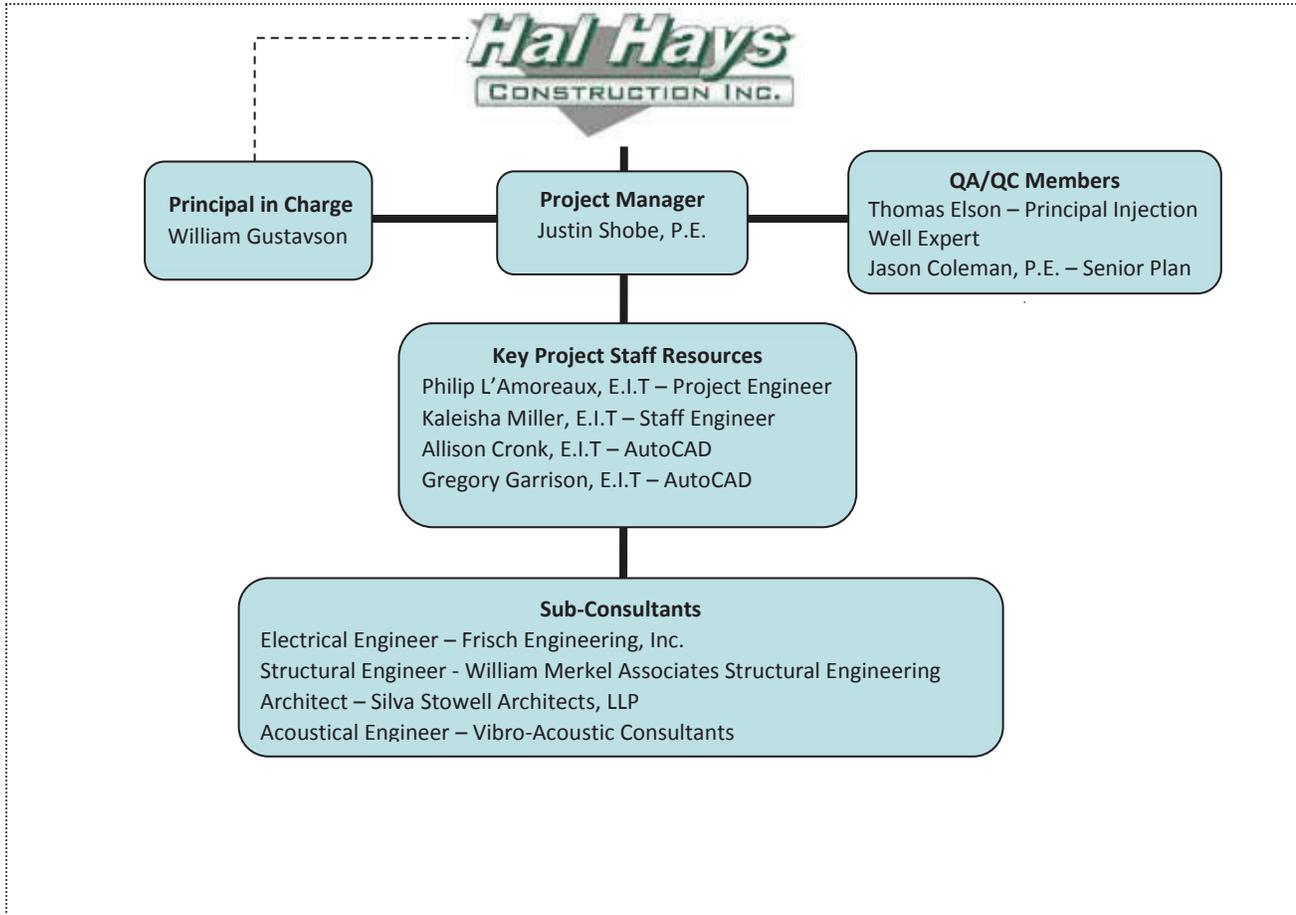

13. Resumes and a work experience history of each individual identified in the project team organizational chart. Identify those individuals with Design Build Institute of America (DBIA) Designated Design-Build Professional™ Certifications. The resumes of those individuals to be associated with the instrumentation and controls design must demonstrate their capabilities in those areas identified in the Scope of Services required for design.

#### Project Delivery Team Resumes

The following **List** presents HHCI's project delivery team for the **Fitch Park ASR Wells 5 & 6 Above Ground Facilities Design Build Project** and the DBIA Certifications (if applicable) for each team resource.

- Principal in Charge- **Kirby S. Hays**
- Corporate Scheduler – **Matt Goddard**
- Corporate Quality Control Manager – **Jason Flowers**
- Corporate Safety Manager – **Tom Lancaster**
- Operations Manager – **Tom Bailey**
- Project Manager – **Steven Yates**
- Superintendent/QC Manager/Site Safety Health Officer – **Tom Vertrees**
- Project Engineer – HHCI Project Engineering Team

HHCI has selected the above team members for the Fitch Park ASR Wells 5 & 6 Above Ground Facilities Design Build Project Delivery Team (PDT), however as the project develops, the firm will supplement these resources with additional support and specialty staff members.

HHCI's Project Manager maintains experience in **facility construction and heavy civil construction** projects and is ready to meet the project's scheduled completion dates.

The Project Manager will:

- (1) Serve as the **single point of contact** throughout the project's duration
- (2) Be at the Jobsite **at all times** during construction, and
- (3) Will be **authorized to speak and act on** HHCI's behalf.

Please refer to the enclosed **Appendix A-1** for the Professional Resumes for the Fitch Park ASR Wells 5 & 6 Above Ground Facilities Design Build Project Delivery Team (PDT).

14. *Specific identification of any design sub-consultants that will be utilized for this project, exclusive of soil boring and survey work. If sub-consultants will be utilized, the resumes of the specific individuals will be required as well as a work experience history of their firms, including three (3) references with specific contacts and phone numbers.*



Silva Stowell Architects LLP (SSA) was founded in 1987 as a service-oriented architectural firm. SSA has maintained a strong focus on healthcare, commercial and industrial-oriented facilities. From small remodel work in existing facilities to planning and designing ground-up buildings, they pride themselves with a responsive approach to supporting our clients.

We help deliver complex spaces that meet the needs of users while facilitating the challenging processes that involve a multitude of stakeholders to ensure successful completion. SSA approaches each opportunity with the understanding that their creative vision is best realized when architectural elements are balanced with the client's budgetary and schedule goals. Silva Stowell believes in combining strengths and constantly improving the methods through which we provide service to our clients. We are committed to our clients. We are proud to say that many of the clients that started at the firm's inception are still our clients today.

## PROJECT EXPERIENCE/REFERENCES

### MULTIPLE PROJECTS, SACRAMENTO REGIONAL TRANSIT DISTRICT

**Type of Service:** Metro Heavy Repair Facility, and Expansion, for maintenance of the Light Rail Vehicle / Fleet CNG Bus Fueling | Service Facility / Bus Maintenance Facility II. Architectural services, from planning and programming, through planning entitlements, schematic design, design development, construction documents and AHJ approvals/permitting. Construction Administration services for the MHRF and MHRF Expansion.

**Reference:** Robert Blume (Contract Administrator) Senior Project Manager, Kimley-Horn & Associates, Inc.  
Sacramento, CA  
[Robert.blume@kimley-horn.com](mailto:Robert.blume@kimley-horn.com)  
916-859-3606

### WALK-IN CARE CLINICS, SUTTER HEALTH

**Type of Service:** A series of tenant improvements throughout Northern California for ambulatory healthcare services. Early conceptual design and establishment of franchise-like standards with value-based selections through team collaboration, ongoing adaptation of model to every facility that the clinics get built out in. Schematic design, construction documents and construction administration services. Design | Build project delivery.

**Reference:** Chris Helbock, Senior Project Manager, Deacon Construction, LLC  
Sacramento, CA  
[Chris.helbock@deacon.com](mailto:Chris.helbock@deacon.com)

### TRAUMATIC BRAIN INJURY FACILITY

**Type of Service:** A series of tenant improvements throughout Northern California for ambulatory healthcare services. Early conceptual design and establishment of franchise-like standards with value-based selections through team collaboration, ongoing adaptation of model to every facility that the clinics get built out in. Schematic design, construction documents and construction administration services. Design | Build project delivery

**Reference:** Chris Helbock, Senior Project Manager, Deacon Construction, LLC  
Sacramento, CA  
[Chris.helbock@deacon.com](mailto:Chris.helbock@deacon.com)



Frisch Engineering was founded in 2001 and has been dedicated to water/wastewater/power industries ever since. Their staff has a combined 130 years of experience, which averages to 20+ years per staff member. Typical projects are

treatment plants, power plants, hydro-electric facilities, sub-stations, pump stations, reservoirs, wells, and sewage lift stations, and telemetry systems. They are proficient in power distribution, protective relaying, hardware controls, PLCs, SCADA, programming, and instrumentation. They are very experienced in automated controls, power coordination, arc-flash safety, and communications since they are used in most projects. Most systems require radio, telephone, and/or LAN/WAN for communications to SCADA. With over 650 projects completed, they are presently working as Consultants in many projects and as Engineers and Construction Partners in Design/Build projects.

## PROJECT EXPERIENCE/REFERENCES

### CAL-AM SACRAMENTO ARDEN BOOSTER PUMP STATION 2018

**Type of Service:** The project is an indoor inline booster pump station that will boost pressure into the Cal-Am service area when pressures are low. The pump station utilizes VFDs pump to control the pressure. The project included a control panel for Cal-Am as well as one for City of Sacramento so that the water could be metered and controlled by both parties.

**Reference:** Lacy Carothers, Project Engineer, California-American Water,  
[Lacy.carothers@amwater.com](mailto:Lacy.carothers@amwater.com),  
916-568-4215

### CAL-AM SACRAMENTO HOWE WELL PUMP STATION 2018

**Type of Service:** The project is a replacement well with all new electrical and controls. The site includes a full speed 150hp well motor, meter/main switchboard, transfer switch, generator, control panel and instrumentation.

**Reference:** Walt Sadler, Engineering Manager, California-American Water  
[Walter.sadler@amwater.com](mailto:Walter.sadler@amwater.com)  
916-568-4213

### SSWD, ENTERPRISE/NORTHROP RESERVOIR BOOSTER PUMP STATION 2005

**Type of Service:** The new booster station utilizes ten vertical turbine 60 thru 150 Hp pumps to maintain water pressure in the local area. The station is actually two stations in one as there are two suction pressure zones (the tank and City of Sacramento inlet). The discharge is to the Sac Suburban system. The station operates on pressure and time of day. If the pumping enable windows are satisfied (i.e. 4 to 11am and 5 to 11pm) the pumps are allowed to pump into the system to maintain pressure. If the pumping enable windows are not satisfied, the reservoir is allowed to fill off of the system via a solenoid operated altitude valve. The electrical system included a 2000 Amp, 480 volt utility metering, an automatic transfer switch and 1500 KW diesel generator, and a motor control center with ten VFDs, active harmonic attenuation and miscellaneous controls. A PLC and Operator interface and radio telemetry was designed into the controls of the system. Chemical feed system provisions were designed for chlorine and future fluoride feed system. Instrumentation included magnetic Flowmeters, pressure transmitters, tank level transmitters, tank floats and chemical analyzers.

**Reference:** John Valdes, Sacramento Suburban Water District, Project Manager  
[jvaldes@sswd.org](mailto:jvaldes@sswd.org)  
916-972-7171



Vibro-Acoustic Consultants formed in 2001 to provide specialty engineering solutions to industries and institutions worldwide. They offer a full array of vibration, noise, and EMI design consulting and

monitoring services. Their specialty is noise and vibration design and monitoring in demanding settings. Their extensive experience in vibration, acoustics, and noise control for publicly-funded Projects include:

- **Environmental Modeling:** Planning and predictive modeling of noise and vibration
- **Environmental Monitoring:** Long-term and construction-phase monitoring of vibration and noise
- **Test & Measurement:** Site environmental review, performance verification, compliance testing
- **Noise, Vibration, and EMI/RF:** emissions control design for construction and operations
- **Mechanical Systems:** Layout, selection, isolation system, HVAC noise and vibration control
- **Structural Dynamics:** Structural design, finite element analysis for vibration performance

*Vibro-Acoustic Consultants are certified MBE/LBE by the San Francisco Contract Monitoring Division, Certificate CMD011814325.*

## PROJECT EXPERIENCE/REFERENCES

### OCEANWIDE CENTER HIGH RISE TOWERS VIBRATION / NOISE MONITORING

**Type of Service:** Oceanwide is developing two high-rise residential and commercial towers in San Francisco. Project requires multiple vibration and noise monitoring at adjacent sensitive buildings which include historical fragile buildings. We have a total of seven noise and vibration monitors support the project construction.

**Reference:** Eddie Peng, Oceanwide Center  
[eddie.pang@oceanwidecenter.com](mailto:eddie.pang@oceanwidecenter.com)  
415-875-7865

### CALAVERAS DAM REPLACEMENT VIBRATION / NOISE MONITORING

**Type of Service:** SFPUC (Calaveras Dam, 2011~2019): Vibration and noise control planning and monitoring for the Contractor. The remote location drove the decision to use independent wireless/solar-powered stations to monitor four years of heavy earthworks and blasting.

**Reference:** Gary Redeker  
[gredeker@suket.com](mailto:gredeker@suket.com)  
714-292-3140

### VAPA PALO ALTO

**Type of Service:** VA hospital in Palo Alto is constructing a new hospital adjacent to their existing hospital. Vibration and noise from construction to patients' rooms and ICU and other critical spaces were of paramount importance. We have installed a total of 20 monitors for this project. The project is still under construction

**Reference:** Ivy Wong  
[job751@sjamoroso.com](mailto:job751@sjamoroso.com)  
650-409-2432



William Merkel Associates is a professional organization involved in Structural Engineering and Design. Their firm provides structural studies, estimates, design and plans, specifications and field supervision, as well as OSHPD pre-approval services for medical equipment manufacturers. They offer services from feasibility studies and design development through construction supervision. Their firm has worked on a variety of projects, including schools, hospitals, churches, office buildings, shopping centers and industrial warehouses. William Merkel is directly in charge of every aspect of a project; from initial discussions of the project to preliminary design and layout and preliminary calculations for estimating. They

have a good working relationship with many approval agencies, including; local city and county agencies, state agencies such as OSA and OSHPD, and ICBO.

## PROJECT EXPERIENCE/REFERENCES

### DIABLO WATER DISTRICT – CHEMICAL FEED FACILITY

**Type of service:** William Merkel has provided structural engineering services to Luhdorff & Scalmanini Consulting Engineers (LSCE) for over 20 years for their municipal water facility designs. As subconsultant to LSCE, Mr. Merkel recently completed design and construction oversight of a chemical feed facility for the Diablo Water District. The facility was required to provide chemical disinfection of a new development planned to occur outside of the existing water system. The chemical feed takes water from the distribution system and injects with chlor-amination chemicals. Three separate rooms were provided to separate the chlorine, ammonia and electrical controls. The building was a CMU block construction with metal roofing and panic hardware on the doors. Mr. Merkel prepared structural design, calculations and inspections to comply with local building and fire department requirements.

**Reference:** Consultant Contact: Luhdorff & Scalmanini CE, Jason Coleman, P.E., (530) 661-0109  
Client Representative: Diablo Water District,  
Mike Yeraka, General Manager (925) 625-6159

### SUTTER AUBURN FAITH PATIENT DROP-OFF STRUCTURE

**Type of service:** This project was a required structure by the California Building Code to provide patients must have a covered area for drop off or pick up. The facility required a paved loading area with a covered structure to provide protection from the weather elements. William Merkel provided the design of a covered structure, from the preliminary Design to working drawings, agency submittal, both the local agency and the State of California Office of Statewide Health Planning and Development (OSHPD) review. As Prime Design Structural Engineer, Mr. Merkel engaged the services of an Architect to provide functional and aesthetic features in the design, and Electrical Engineer for lighting and power. Mr. Merkel oversaw the construction and attended construction meetings through project completion.

**Reference:** Hospital Representative: Mario Pereira, Engineering Manager (530) 889 6033  
Contractor: Rudolph-Sletten, Matt Pohley, Superintendent (916)781 8001



Pacific Crest Engineering Inc. (PCEI) was founded in 2001 to provide services related to geotechnical, environmental and chemical process engineering to the Monterey Bay and Silicon

Valley areas. The Geotechnical Group specializes in geotechnical engineering and environmental consulting services related to soils and groundwater contamination issues. The office includes a fully equipped laboratory facility where they perform a variety of soil, asphalt and concrete testing. PCEI's special inspection services include sampling and testing of concrete and masonry, inspection, sampling and testing of earthwork operations, inspection, sampling and testing of hot mix asphalt, geotechnical review of design documents, field observation of grading operations, and Cal-Trans assurance testing. *They are a certified woman-owned DBE (#41551) and Small Business (#47199) with the State of California.*

## PROJECT EXPERIENCE/REFERENCES

### MONTEREY PENINSULA DESALINATION INFRASTRUCTURE PROJECT

**Type of service:** The Monterey Peninsula Desalination project consists of a proposed seawater desalination and treatment facility to be constructed by California American Water Company in Marina, California. The ~\$87M project will be constructed on a 376 acre parcel comprised of ancient sand dune fields near the mouth of the Salinas River. The new facility will include treatment plant facilities, water tanks, pumps, pressure filters and piping networks associated with the operation of the desalination plant.

**Reference:** Michael Zafer, PE , CDM Smith

[ZaferMA@cdmsmith.com](mailto:ZaferMA@cdmsmith.com)

(925) 933-2900

### PURE WATER MONTEREY – GROUNDWATER INJECTION WELL FACILITIES

**Type of service:** In 2016 Pacific Crest Engineering performed a design-level geotechnical investigation for the proposed design and installation of four (4) groundwater injection well sites with attendant utilities and electrical buildings, a new backflush basin, and road improvements for access to the monitoring wells. Field exploration included subsurface borings, CPT and infiltration testing, which required intense coordination with the design team as well as army base personnel. Preliminary recommendations and data were provided to the design team as the various phases of field work were completed.

**Reference:** Andrew A. Sterbenz, PE I Schaaf and Wheeler

[asterbenz@swsv.com](mailto:asterbenz@swsv.com)

(831) 883-4848

### MRWPCA SALINAS SOURCE WATER IWW DIVERSION PROJECT

**Type of service:** As part of the Monterey Regional Water Pollution Control Agency (MRWPCA) Salinas Industrial Wastewater and Storm Water Storage and Recovery project, a new storm water diversion structure was constructed at the Salinas Pump Station in Monterey County. The structure was to be constructed at an elevation of approximately 20 feet below existing grades in an area underlain with many existing utilities including sanitary sewer and storm drains. Persistent, long term leaking from the sewer main and adjacent storm drain pipe resulted in significant softening of the subgrade at the base of the excavation. The exposed subgrade was deemed to be too unstable for adequate support of the proposed vault structure, which was to be founded upon a structural mat foundation system.

**Reference:** Loren Weinbrenner, PE, E2 Consulting Engineers

[loren.weinbrenner@e2.com](mailto:loren.weinbrenner@e2.com)

(510) 428-4733

15. A preliminary schedule for design, permitting, construction, testing, startup and commissioning of the project from date of award in Gantt chart form. If the time of completion desired by Owner is not acceptable, it shall be explicitly stated in the proposal. The schedule shall identify long lead time equipment and critical path to completion.

The attached **CPM Project Schedule** includes required **milestones** and **critical path** for the Fitch Park ASR Wells 5 & 6 Above Ground Facilities Design Build Project.

**Matt Goddard, HHCI Corporate Scheduler**, is responsible to assure that a:

- **detailed work schedule** for the site(s) are completed prior to commencing work
- **weekly** schedule updates are provided
- **weekly project dashboard** sent out every Friday
- **two-week look-ahead** schedules are prepared for the project duration



HHCI CPM Project Schedule

All schedules will be **coordinated** with the CAW Project Manager to minimize any possible disruptions.

This project schedule is also incorporated into HHCI's **Master Program Schedule** to provide HHCI Executive Leadership and Operations Managers with a snapshot of all HHCI projects outlining dates for key areas, for examples: design, Notices to Proceed (NTP), pre-construction submittals, **construction submittals**, **critical path items**, **long lead items**, **construction activities**, **phases**, **closeout requirements**, and **completion dates** to better plan and coordinate program-wide resources.

This scheduling methodology is a **tried and tested, data-driven tool** to support on-time or early completions of multi-site, concurrent work orders in the most effective, efficient and cost/resource-saving manner



HHCI Weekly Project dashboard

#### HHCI Weekly Project Dashboard:

HHCI's new innovative tool that we use with all of our clients is called the Project Dashboard. HHCI developed a weekly project dashboard that we send out for all of our projects every Friday to the client. The idea is to increase communication and also give our clients a good handle of the health of each of our projects in a fast, 30-second window. The project dashboard touches on **Key Performance Indicators** related to **safety, quality, schedule, finance, submittals, etc.** It also does a good job of ensuring our Project Managers are looking at items down the line and not just what's in front of them

Solicitation # CAW

CAW Fitch Park ASR Wells 5 and 6 Above Ground Facilities  
Seaside, CA

HHCI Project No. 18201

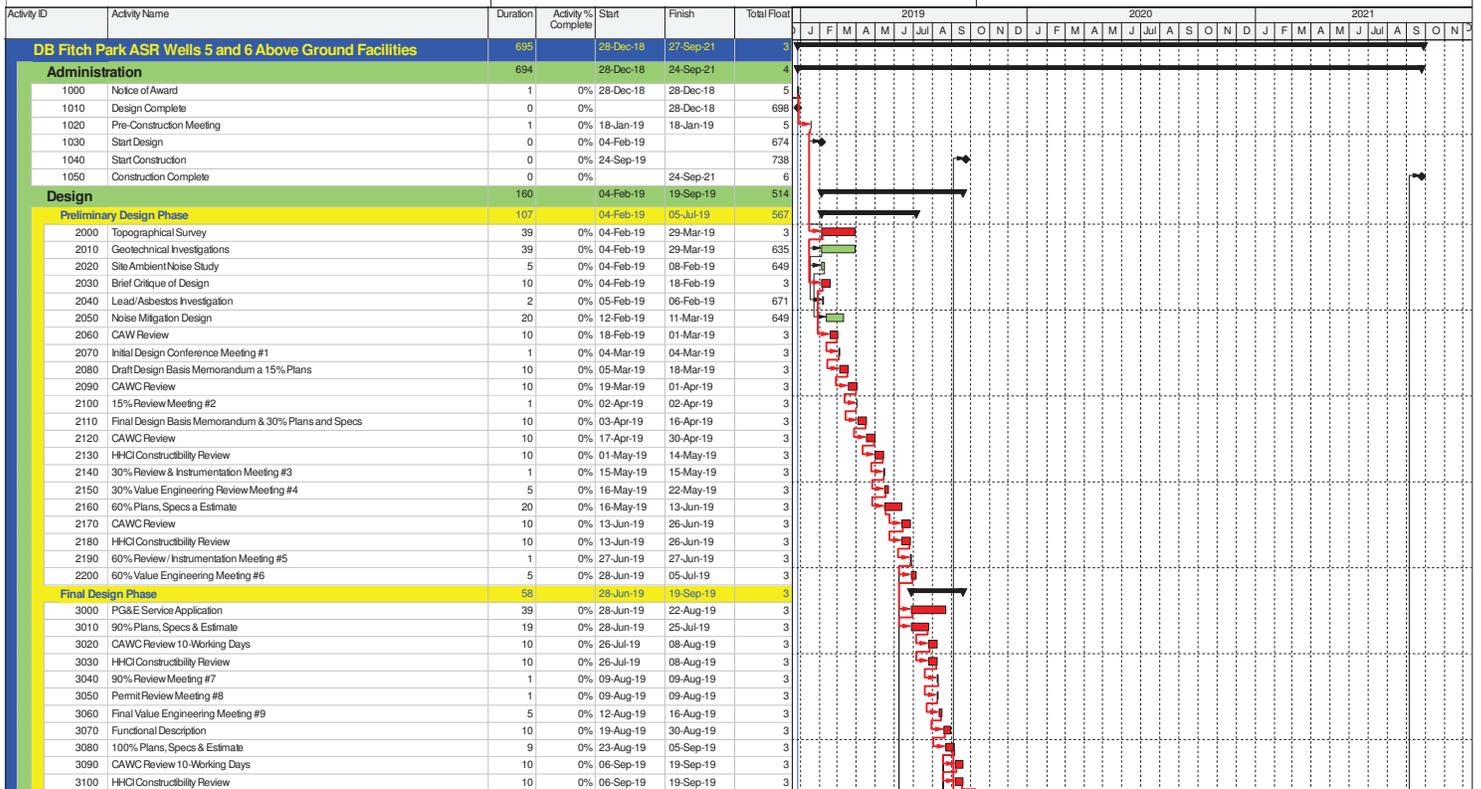













*16. Identify a list of major and critical shutdowns anticipated to complete the project.*

Depending on the timing that the 16” transmission and backflush lines are installed, HHCI may encounter a critical shutdown under the following circumstance:

- If lines become active before installation of yard piping, HHCI will have to shut down activity in order to connect new lines to the transmission and backflush lines.

*17. Concurrence that Design/Builder has read the Proposed Design/Builder Contract Documents included in the Attachments and are prepared to enter into this Agreement, should Design/Builder’s proposal be accepted by Owner.*

**Hal Hays Construction, Inc. and Luhdorff & Scalmanini, Consulting Engineers concur** that they have read the proposed Design/Builder Contract Documents included in the attachments of this RFP and are prepared to enter in to this Agreement with CAW, should our proposal be accepted by the owner.

18. *Specific information describing how Design/Builder's firm plans to establish electronic communications with Owner if these capabilities are not already in place.*

### **Project Management Vision**

As a long term design builder, HHCI practices an Integrated Project Deliver team philosophy, emphasizing: (1) Goals aligned for all major team members, (2) Increased collaboration, (3) Flexible support of other team members, (4) Constant push to do things better, (5) Accountability among team members, and (6) The team succeeds together (failure is not an option).

### **Project Management System**

Supporting the team's collaboration and management of multi-site, concurrent projects, HHCI employs **SAGE MasterBuilder Construction Management system** that links: **estimating, scheduling, contract and project management, accounting, billing, procurement, subcontracts, equipment, document control, payroll and financial performance reporting** into one integrated process. In order to meet program requirements such as managing concurrent projects of various dollar values, disciplines, and geographic locations, HHCI follows these tactics:

- Following project award, a Project Manager and Superintendent are officially assigned by the **Program Manager**. Typically team definition is already established during the bid and proposal process.
- In consultation with the Program Manager, the Project Manager and Superintendent tailor the project delivery team (Foreman, Crew, and Support Staff) depending upon a **project's scope, locale, delivery method, complexity, site, and environmental factors**. Specifically, each project is reviewed to ascertain:
  - Staffing levels, project skills, and experience required
  - Potential labor, subcontractors, designer, and subconsultants
  - Specific team member's expertise and availability
  - Familiarity with regional area and facility type
- **Project subcontracting, submittal preparation, and computer file preparation tasks** are executed by the Project Support staff under the guidance of the Project Manager.
- **Wide Area Computer Network:** Project Management, Quality Control, Safety, and Superintendent teams use a network of iPad, desktop, and mobile laptops for **daily** project management coordination. This system employs **Microsoft Office Professional** and **Sage 100 Contractor Construction Management Software** to coordinate project information, scheduling, resources, and budgetary information. HHCI Corporate provides **web-based project coordination** via MS Outlook Exchange with access to HHCI's main server and individual workstations via internet connections **24/7**.
- **High speed Internet Access via PDA devices, Smart devices, and Fiber Optic lines.**
- **Advanced Telecom & Emergency Communication Tools**-Satellite Phones, Smart Phones, Internet Messaging/Email and Paging System, **Teletrak (office to vehicle)** and **GPS technology**.
- **Project buy-out** of subcontractor/consultants is conducted by the Project Manager
- **Procurement** of materials/supplies/equipment is conducted by the Project Manager
- The Project Manager conducts a **project kick-off meeting** with pre-qualified subcontractors, QCM/Project Superintendent/SSHO, Admin, Financial and Scheduling staff.
- **Depending on project scope and phase**, relevant submittals and schedules are prepared/finalized by the Project team with assistance from Project Support staff.
- Project **preliminary schedule and resources** are entered into the HHCI computer network.
- **Control budgets and financial planning** documents are created by the Project Support staff.
- During the **construction phase**, the Project Team arranges for procurement, shipment, project financial tools, site security, and overall project logistics.

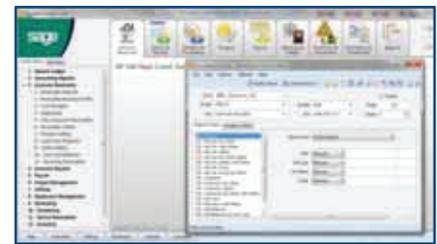

**SAGE 100 Contractor CM System**



- **Project-specific network/communication access** is created for transmission of project information and documents via the Internet (when required and available).
- **Financial and contractual monitoring** documents are prepared by Corporate staff in conjunction with the Project Manager.

To meet program demands, HHCI employs the following **Project Management** and **Field Coordination procedures and tools**:

▪ Pre-Construction Conferences	▪ Collaboration Meetings	▪ Pre-Construction Submittal Development Process
▪ Project Schedules	▪ Project Look-Ahead Schedules	▪ Equipment Scheduling Forecast
▪ Construction Submittal Review & Approval Processes	▪ Material & Supply Procurement Process	▪ Daily Production Meetings
▪ Weekly Project Meetings to Executive Management	▪ Quality Control Preparatory Meetings	▪ Safety Inspections
▪ Executive & Operations Team Onsite Observations	▪ QC Inspections	▪ System Testing Process
▪ Red Zone Close Out Meeting	▪ Work In Progress Meetings	▪ Sage 100 Contractor CM Software
▪ Dispatch Procedures	▪ Lean Scheduling Practices	▪ Integrated Project Delivery

The field team has open lines of communication during construction to resolve unforeseen issues. This hands-on attention makes the difference in project execution by maximizing the **project communication** flow while minimizing conflicts, project delays, and cost overruns.

For **design build**/adapt projects, the Lead Design Firm is involved **on a continual basis** during construction to assist the construction team in addressing any unforeseen issues. The construction Project Manager, Superintendent, Quality Control Manager, Safety Manager and Design Quality Control Manager have open lines of communication during construction to resolve unforeseen issues.

With the support of the above software tools, HHCI practices an Integrated Project Deliver team philosophy, emphasizing: (1) Goals aligned for all major team members, (2) Increased collaboration, (3) Flexible support of other team members, (4) Constant push to do things better, (5) Accountability among team members, and (6) Philosophy that the team succeeds together (failure is not an option).

19. Evidence of Proposer's qualifications to do business in the State where the Project is located (See GPI-3.01).

Mr. Kirby Hays, **RMO/CEO/President**, is HHCI's key individual to hold the firm's licenses:

**Contractor's License Detail for License # 667560**

- **A** - GENERAL ENGINEERING CONTRACTOR
- **B** - GENERAL BUILDING CONTRACTOR
- **C12** - EARTHWORK AND PAVING
- **C21** - BUILDING MOVING, DEMOLITION

**Certifications**

- **HAZ** - HAZARDOUS SUBSTANCES REMOVAL



## CONCLUSION

### WHY HHCI IS ESPECIALLY QUALIFIED TO UNDERTAKE THE CAW FITCH PARK ASR WELLS 5 & 6 ABOVE GROUND FACILITIES DESIGN BUILD PROJECT

Founded in 1991, HHCI, an award-winning General & Civil Construction firm, offers CAW:

- ◆ Experienced project teams representing over **1,200+** years of expertise.
- ◆ Company experience in **Public Utility Agency projects**, including **relevant projects** with outstanding performance evaluations.
- ◆ Trained personnel in **CQC process, Cal-OSHA, OSHA, SCE Health & Safety Handbook for Contractors, Work In Energized Sites, and EM 385 1-1 Safety Programs.**
- ◆ **Exceptional, industry-leading** safety record in EMR percentage DART, and TI&IR.
- ◆ **HHCI executive management** actively involved in **project performance**, including Founder Hal Hays and CEO Kirby Hays who will be continually involved in project operations.
- ◆ **Proven OUTSTANDING or EXCEPTIONAL** project performance. HHCI's documented **past performance** evaluation ratings include: **47 Outstanding, 6 Exceptional, 2 Excellent, 48 Above Average, and 2 Very Good** performance evaluations. The firm has earned many **OUTSTANDING** ratings in the areas of Quality of Work, Timeliness of Performance/Delivery, Cooperation, Business Relations, and Customer Satisfaction/Overall.
- ◆ **Edison KPI Project Performance Ratings of 3.9/4.0, first ever by a Contractor.**
- ◆ Self-performing crew resources including **89 crew members.**
- ◆ **SCE experienced pre-qualified suppliers, vendors, and union** (when required) **subcontractors.** Plus **advanced technology systems** including **SAGE 100 Contractor Contract Management software system** for contract, project, financial, and equipment management.
- ◆ In recognition of its quality work and project performance, HHCI continues to earn industry awards/recognition, such as: **SCE's 2018, 2017, 2016 and 2015 Supplier of the Year, 2016 Western Region SOTY, 2017 ENR Top California General Contractor Listing, 24 STAR NAVFAC Safety Awards, California Small Business of the Year, and multiple Top Diversity Business Awards** such as the **2017 Top Minority Contractor in the US, and the 7<sup>th</sup> Largest Native American Owned and Diversity Owned Business** in California and the Nation.

*"[HHCI] always makes every effort to support SCE the best way they can. My personal experience with them has been **exceptional** all the way. [They are a] very **professional company** that adheres to all OSHA, EH&S rules and requirements."*

**-Eddie Villa, SCE Facility Manager**

By offering the above benefits, unique skills, and accomplishments, HHCI helps its clients achieve their missions of improving or maintaining key facility and civil and infrastructure assets. The Project Delivery Team stands ready to provide its award-winning service for this key project!

On behalf of HHCI's leadership and dedicated employees, we thank California American Water for the opportunity to participate in the Fitch Park ASR Wells 5 & 6 Above Ground Facilities Design Build Project, and we look forward to working with your team on this key project.



---

## Appendix A-1

Professional Resumes for  
**CAW Monterey Peninsula Water Supply Project**  
**Design Build of Fitch Park ASR Wells 5 & 6 Above**  
**Ground Facilities [Hal Hays Construction, Inc.](#)**  
Project Delivery Team.



Hal Hays Construction Inc.									
NAME	ROLE IN THIS CONTRACT	YEARS EXPERIENCE							
		a. TOTAL	b. WITH CURRENT FIRM						
<b>Kirby Hays</b>	Principal In Charge/CEO	17 Years	17 Years						
<b>FIRM NAME AND LOCATION (<i>City and State</i>)</b> Hal Hays Construction, Inc., Riverside, CA									
<b>EDUCATION (<i>Degree, Specialization, Training &amp; Certification</i>)</b> <ul style="list-style-type: none"> <li>▪ 2002 – Current, Crafton Hills College Business Administration and Engineering</li> <li>▪ Class A Contractors License (General Engineering)</li> <li>▪ Class B Contractors License (General Building)</li> <li>▪ Class C-8 Contractors License (Concrete)</li> <li>▪ 2008 SureTrak Certified</li> <li>▪ 2004 NAVFAC Quality Control Certified</li> <li>▪ 2004 10-Hour OSHA Safety Training for Construction Industry Certified</li> <li>▪ 2008 ABC Estimating 101</li> <li>▪ 2008 ABC Starting a Construction Project</li> <li>▪ Subcontractor &amp; Site Safety Management Training</li> </ul>									
<b>OTHER PROFESSIONAL QUALIFICATIONS (<i>Relevant</i>)</b> Mr. Hays has extensive Department of Defense, Government, Public Works, and Design Build experience related to wet utilities, heavy civil, and new construction. Mr. Hays maintains specific experience in this project's work areas such as: wet utilities, BMP implementation; demolition; heavy civil and grading; demolition, potable water systems, sewage mains, earthwork, pipe installation, installation of wet wells; and traffic control measures  <b>Software Skills:</b> MS Windows Professional - MS Office Suite, SureTrak, and Sage Master Builder  <b>Job Skills:</b> Project Management, Quality Control, Scheduling, and Safety Tasks  For the following projects, Mr. Hays executed the role of Principal in Charge, including: program-wide coordinating and negotiations; recommendation of design and project changes to provide the client the best value for their project; provision of technical oversight and program-wide resource management including project construction methods consultant, program planning for staffing, scheduling, logistics, and project resources, technical consultation with A/E and subcontractors, safety and quality management consultation with project teams.									
<b>EMPLOYMENT HISTORY</b> <table style="width: 100%; border-collapse: collapse;"> <tr> <td style="width: 15%;">2014 - Present</td> <td style="width: 45%;">Hal Hays Construction, Inc., Riverside CA</td> <td style="width: 40%;">Project Executive/President &amp; CEO</td> </tr> <tr> <td>2001 - 2013</td> <td>Hal Hays Construction, Inc., Riverside CA</td> <td>General Manager/Project Manager</td> </tr> </table>				2014 - Present	Hal Hays Construction, Inc., Riverside CA	Project Executive/President & CEO	2001 - 2013	Hal Hays Construction, Inc., Riverside CA	General Manager/Project Manager
2014 - Present	Hal Hays Construction, Inc., Riverside CA	Project Executive/President & CEO							
2001 - 2013	Hal Hays Construction, Inc., Riverside CA	General Manager/Project Manager							



The following projects represent both vertical and horizontal construction examples where Kirby Hays served as **Principal in Charge/CEO** for project sites throughout California.

**LIST OF COMPLETED PROJECTS EXPERIENCE**

Project Name & Type of Work	Owner Name	Contract Completion Value	Final Completion Date
RCTC Rail Station Improvements/ Civil Construction	Riverside County Transportation	\$1,123,148.00	02/22/2018
SCE San Dieguito Wetlands/ Civil Construction	SCE	\$1,293,949.00	07/28/2017
El Campo Rd Water Main/ Wet Util. Civil Construction	Golden State Water Co.	\$850,288.60	12/30/2017
Elsinore Wash Rack and Site Improvements/ Civil Construction	Caltrans	\$1,802,701.00	11/17/2017
Ontario Police Headquarters Renovation/General Construction	City of Ontario	\$2,386,111.20	10/19/2017
Plant 11 Phase 2 Improvements/ Wet Util, Civil Construction	San Gabriel Valley Water Co.	\$619,600.60	01/10/2017
DB Repair Water Tank/Wet Utility Construction	US Navy	\$1,055,000.00	07/27/2015
DB Improve Intersections/ Civil Construction	US Navy	\$851,528.88	12/09/2016
DB Overhead Utilities Relocate/General Construction	US Army-Louisville	\$4,342,235.14	12/31/2016
DB Repair Area 52 Roads/Civil Construction	US Navy	\$1,564,025.83	12/20/2016
DB Replace Fire Main/ General Construction	US Navy	\$1,271,060.00	06/30/2015
DB Repair Recirculation Lines/General Construction	US Navy	\$1,190,495.00	12/03/2016
DB Repave Various Lots/Civil Construction	US Navy	\$1,838,948.00	12/15/2016
Repairs to Asphalt Parking/Civil Construction	US Navy	\$815,518.00	12/26/2015



RELEVANT PROJECTS		
a.	(1) TITLE AND LOCATION <b>Riverside Downtown Commuter Rail Station Improvements</b> Riverside, CA	(0) YEAR COMPLETED 2018
	(3) BRIEF DESCRIPTION AND SPECIFIC ROLE <input checked="" type="checkbox"/> CHECK IF PROJECT PERFORMED WITH CURRENT FIRM  The project includes construction of the Riverside Downtown Commuter Rail Station improvements, including TVM relocation, pedestrian shelters, cart barn, and ADA and parking lot upgrades.  <b>Cost: \$1M                      Role: Principal-In-Charge</b>	
	(1) TITLE AND LOCATION <b>City of Ontario Police Department Interior Renovations</b> Ontario, CA	(2) YEAR COMPLETED 2017
	(3) BRIEF DESCRIPTION AND SPECIFIC ROLE <input checked="" type="checkbox"/> CHECK IF PROJECT PERFORMED WITH CURRENT FIRM  The project consisted of the construction of approximately 11,000 SF of tenant improvements, including a Dispatch Center, Watch Commander's Office, Briefing Room, Storage Rooms, private offices, etc. The improvements will include infrastructure for an extensive Owner-provided Audio-Visual system, 24-hour HVAC system in equipment room, and decorative ceiling systems with specialty lighting. Trades will include, but are not limited to: demolition, drywall and framing, electrical, plumbing, mechanical (HVAC), doors/frames/hardware, glazing, paint, floor finishes, acoustical ceilings, low-voltage cabling, etc.  <b>Cost: \$2.3M                      Role: Principal-In-Charge</b>	
	(1) TITLE AND LOCATION <b>San Dieguito Excavation &amp; W6A Construction</b> Del Mar, CA	(2) YEAR COMPLETED 2017
	(3) BRIEF DESCRIPTION AND SPECIFIC ROLE <input checked="" type="checkbox"/> CHECK IF PROJECT PERFORMED WITH CURRENT FIRM  This project for Southern California Edison was for the excavation and construction to implement San Dieguito river restoration solutions, including: hydroseeding, erosion control, inlet maintenance, excavation, dredging, and earthwork, lagoon revetment, heavy equipment operations, berms, erosion control, floodwalls, raised elevations, paving, slope protections and retaining walls.  <b>Cost: \$1.4M                      Role: Principal-In-Charge</b>	
b.	(1) TITLE AND LOCATION <b>Design Build Renovate 3 Buildings and a Parking Lot</b> Air Force Plant 42, Palmdale, CA	(2) YEAR COMPLETED 2014
	(3) BRIEF DESCRIPTION AND SPECIFIC ROLE <input checked="" type="checkbox"/> Check if project performed with current firm  This <b>Design Build</b> project was for renovation of buildings 552, 553, and 560 and a parking lot at Air Force Plant 42 in Palmdale, CA for USACE. The scope of work included: renovation of a 7,101 SF, 5,345 SF, and 5,782 SF buildings, along with a newly constructed <b>42,975 SF A/C paved parking lot</b> , including: hazardous material abatement; <b>demolition</b> ; masonry wall structural upgrades; mechanical system upgrades; electrical system upgrades; interior partition walls; suspended panel ceilings; restroom renovations; convenience centers; flooring; exterior trash enclosure with <b>concrete pad</b> and CMU walls; <b>parking lot construction</b> , including <b>grading</b> and <b>excavation</b> ; <b>sub-base preparation</b> ; <b>asphalt pavement</b> ; <b>signage</b> and <b>striping</b> ; SWPPP and <b>BMP implementation</b> ; and <b>landscaping</b> . Work was completed at secured, active military airfield with operational facilities. The	

	<p>renovation of Building 552, a single story masonry structure, approximately 7,101 SF, included the removal of existing interior finishes; abatement of hazardous materials; structural upgrades to existing masonry walls for code compliance; reconfiguration of interior spaces for ABA compliance; and creation of open-plan office arrangements. The renovation of Building 553 included: a single story masonry structure; approximately 5,345 SF; removal of existing interior finishes; abatement of hazardous materials; structural upgrades to existing masonry walls for code compliance; reconfiguration of interior spaces for administrative and training offices; a guard assembly and resources room; restrooms; locker/change rooms; a BDOC; and a masonry addition to house mechanical, electrical, and telecommunications equipment; and provided space for storage of security items. The renovation of Building 560 included: a two story pre-engineered metal building, approximately 5,782 SF removal of interior partition walls; abatement of hazardous materials; reconfiguration of the first floor restrooms to comply with ABA requirements; installation of new convenience centers; replacement of floor finishes; suspended panel ceilings; and repairs to the existing vehicle parking area adjacent to Building 560 to provide ABA required accessible routing. The new parking lot will be located south of Building 560 and east of the AF Plant 42 Control Tower. The parking lot shall provide approximately 115 parking stalls, including ABA compliant and motorcycle stalls to serve Building 553's existing fire station and the control tower.</p> <p><b>Cost:</b> \$5.5M                      <b>Role:</b> President/CEO</p>	
c.	<p>(1) TITLE AND LOCATION (<i>City and State</i>)</p> <p><b>Design Build Repair Hangar 3 &amp; 4 Doors</b> Marine Corps Air Station, Miramar, CA</p> <p>(3) BRIEF DESCRIPTION (<i>Brief scope, size, cost, etc.</i>) AND SPECIFIC ROLE      <input checked="" type="checkbox"/> Check if project performed with current firm</p> <p>This <b>Design Build</b> project was to repair hangar doors 3 and 4 at the Marine Corps Air Station, Miramar, CA for NAVFAC SW. The scope of work included: <b>demolition</b>; building renovations; structural steel renovations; operational facilities; electrical systems; and <b>working on a secured and active military airfield facility</b>.</p> <p><b>Cost:</b> \$3.9M                      <b>Role:</b> Project Manager</p>	<p>(2) YEAR COMPLETED</p> <p>2013</p>
d.	<p>(1) TITLE AND LOCATION (<i>City and State</i>)</p> <p><b>Design Build Renovation of Exterior NEX Complex Bldg. 16</b> Naval Base Ventura County, Point Mugu, CA</p> <p>(3) BRIEF DESCRIPTION (<i>Brief scope, size, cost, etc.</i>) AND SPECIFIC ROLE      <input checked="" type="checkbox"/> Check if project performed with current firm</p> <p>This <b>Design Build</b> project was for exterior renovation of the NEX complex building 16 at the Naval Base Ventura County, Point Mugu, CA for NAVFAC SW. The scope of work included: <b>demolition</b>; abatement; renovation; mechanical systems; plumbing systems; <b>electrical systems</b>; <b>underground utilities</b>; <b>concrete</b>; and working on a secured and active military facility. This <b>project received an Outstanding performance evaluation rating</b>.</p> <p><b>Cost:</b> \$1.6M                      <b>Role:</b> Project Manager</p>	<p>(2) YEAR COMPLETED</p> <p>2012</p>
e.	<p>(1) TITLE AND LOCATION (<i>City and State</i>)</p> <p><b>Replace Water System Phase II</b> Vandenberg AFB, CA</p> <p>(3) BRIEF DESCRIPTION (<i>Brief scope, size, cost, etc.</i>) AND SPECIFIC ROLE      <input checked="" type="checkbox"/> Check if project performed with current firm</p> <p>This project was for the replacement of a water system, Phase II, Vandenberg AFB, CA for the U.S. Army Corps of Engineers. The project mandated the provision of all labor, material and equipment necessary to <b>abandon and cap-off approximately 1,200 LF of existing 6"; 15,200 LF of 8"; 1,800 LF of 12"; 4,900 LF of 21" piping system; appurtenances in the main cantonment area</b> at Vandenberg Air Force Base; and replace the old system with new HDPE water pipe system. The scope of work included: <b>demolition; clearing and grubbing; excavation; backfill; compaction; saw-cutting existing asphalt roadways; disposal of debris; trench-line excavation; concrete work; replacement of concrete curbs; gutters, sidewalks and asphalt paving to effect installation of the new</b></p>	<p>(2) YEAR COMPLETED</p> <p>2010-2011</p>



	<p>pipng systems; pressure testing new system; flushing and sterilizing system; bacteriological testing; and re-seeding and landscaping disturbed areas.</p> <p><b>Cost:</b> \$1.6M                      <b>Role:</b> Project Manager</p>	
f.	(1) TITLE AND LOCATION ( <i>City and State</i> )	(2) YEAR COMPLETED
	<p><b>Design Build Construct Child Development Center</b> Marine Corps Air Station, Yuma, AZ</p>	2010
	<p>(3) BRIEF DESCRIPTION (<i>Brief scope, size, cost, etc.</i>) AND SPECIFIC ROLE      <input checked="" type="checkbox"/> Check if project performed with current firm</p> <p>This <b>Design Build</b> project was for the construction of a Child Development Center that was 12,750 SF, at MCAS, Yuma, Arizona. The new building was self-certified at LEED Gold, is a separate structure and is sited at the existing tennis courts facility adjacent to the existing Child Care Center in Bldg. 1085. The new single story Annex CDC facility provides 102 additional spaces for new enrollment. Construction consisted of: metal stud exterior walls with stucco; and a standing seam metal roof. The spaces provided included: an entrance lobby; reception/work area; administrative offices; toilet/break staff room; central storage; staff/public toilets; child activity rooms; functional spaces for janitor; laundry; telecommunication; and other facility support spaces. The project included: <b>extensive demolition; grading and excavation; landscape; electrical; and utilities.</b> This <b>project received an Outstanding performance evaluation rating.</b></p> <p><b>Cost:</b> \$4.8M                      <b>Role:</b> Project Manager</p>	
g.	(1) title and location (City and State)	(2) year completed
	<p><b>Design Build Expansion &amp; Conversion of Bldg. 888 ROICC Offices</b> Yuma, Arizona</p>	2010
	<p>(3) BRIEF DESCRIPTION (<i>Brief scope, size, cost, etc.</i>) AND SPECIFIC ROLE      <input checked="" type="checkbox"/> Check if project performed with current firm</p> <p>This <b>Design Build</b> project was for the Expansion and Conversion of Building 888 at Marine Corps Air Station (MCAS), Yuma, AZ. A portion of the existing warehouse area was to be remodeled into a new Resident Officer in Charge of Construction office facility. The expansion of office area into the existing warehouse space consisted of 3,325 SF; and <b>site work to accommodate seven (7) additional parking spaces.</b> The interior remodel portion of this project included: the installation of new finishes; new paint; new flooring; new interior walls; and new ceiling surfaces. In addition, the interior remodel included: 5 private offices; conference room (approx. 396 SF); open office area to include 8 workstations; storage (approx.100 SF); one copy area; and one small coffee area with sink and refrigerator; exterior existing materials are matched to fill-in removed exterior items such as windows and doors; and provide a covered main aluminum-and-glass entrance door assembly. <b>Demolition</b> included: the existing interior/exterior walls; personnel roll-up doors; plumbing fixtures; shower/eye wash; air lines; water heater; service sink; electrical outlets; ventilation ducts; demolition and removal of the deteriorated roof mounted swamp coolers and associated power; and <b>utility connections.</b> In addition, existing shop equipment will be relocated to the adjacent shop space next door. <b>This project received an Outstanding performance evaluation rating along with a Project of Excellence S.A.M.E. Award and Safety Through Awards and Recognition (STAR) Award.</b></p> <p><b>Cost:</b> \$843K                      <b>Role:</b> Project Manager</p>	
h.	(1) title and location (City and State)	(2) year completed
	<p><b>Design Build Install Photovoltaic Systems, Various Buildings,</b> MCAGCC Twenty-Nine Palms, California</p>	2010
	<p>(3) BRIEF DESCRIPTION (<i>Brief scope, size, cost, etc.</i>) AND SPECIFIC ROLE      <input checked="" type="checkbox"/> Check if project performed with current firm</p> <p>This <b>Design Build</b> project was for the installation of Photovoltaic Systems to Various Buildings at Marine Corps Air Ground Combat Center, Twenty-Nine Palms, CA, for the NAVFAC SW. The scope included: the design, construction, permitting, commissioning, and training for a 200-KW DC rooftop solar photovoltaic (PV) system at buildings 1801, 1802, 1803, 1804, 1805, and 1210. The facilities provide shelter for large military tanks. This system consisted of: photovoltaic module array mounted on support brackets for roofs; electrical terminal and combiner boxes; quick-connect electrical connectors; Direct Current (DC) wiring; DC disconnect; grid-connected inverter and</p>	



	isolation transformer; Alternating Current (AC) disconnect; and a web-based data acquisition and monitoring system (DAS). <b>This project received an Outstanding performance evaluation rating and a USACE Safety Through Awards and Recognition (STAR) Award.</b>															
	<b>Cost:</b> \$2.2M	<b>Role:</b> Project Manager														
i.	(1) title and location ( <i>City and State</i> )	(2) year completed														
	<b>Photovoltaic Carport Structure At Parking Lot 4P Pier 8</b> San Diego, California	2010														
i.	(3) BRIEF DESCRIPTION ( <i>Brief scope, size, cost, etc.</i> ) AND SPECIFIC ROLE <input checked="" type="checkbox"/> Check if project performed with current firm															
	<p>This project was for the construction of a Photovoltaic Carport Structure at Parking Lot 4P Pier 8, San Diego, CA. The scope of work included: designing; constructing; and utility interconnection for a 180 KW solar carport photovoltaic (PV) electrical generating system. The PV electrical generating system consist of all components for a complete and usable system including: photovoltaic module array mounted on support brackets; electrical terminal and combiner boxes; quick-connect electrical connectors; Direct Current (DC) wiring; DC disconnect; grid-connected inverter and isolation transformer; Alternating Current (AC) disconnect; and a web-based data acquisition and monitoring system (DAS). <b>This project received an Outstanding performance evaluation rating.</b></p> <p><b>Cost:</b> \$1.6M      <b>Role:</b> Project Manager</p>															
j.	(1) title and location ( <i>City and State</i> )	(2) year completed														
	<b>Design Build Auto Skills Center B1083</b> Twentynine Palms, California	2010														
j.	(3) BRIEF DESCRIPTION ( <i>Brief scope, size, cost, etc.</i> ) AND SPECIFIC ROLE <input checked="" type="checkbox"/> Check if project performed with current firm															
	<p>This <b>Design Build</b> project was for the expansion of an existing Auto Skills Center Building 1083, in Twentynine Palms, CA for NAVFAC SW. The scope of work included: adding 10 additional vehicle repair bays of 6,800 SF to the West end of the building; <b>approximately 6,000 SF of concrete paving around the new addition to match the existing concrete paving</b>; new <b>concrete paving</b> along the North and South side of the new building (connected by a walkway on the West end of the addition); and relocating the employee <b>parking lot</b> and storage compound to the West end. Additional scope of work included: <b>demolition; concrete; asphalt paving; striping and signage</b>; street lights; fencing; area security lighting; relocate existing tire equipment and associated equipment; ceiling; flooring; interior framing; drywall; electrical and <b>plumbing</b>; new access from the existing sales area; and installation of new storefront doors through the common wall. <b>This project received an Above Average performance evaluation rating.</b></p> <p><b>Cost:</b> \$1.6M      <b>Role:</b> Project Manager</p>															
k.	(1) title and location ( <i>City and State</i> )	(2) year completed														
	<b>Relevant Projects-Variou Locations</b>	2001 - 2010														
k.	(3) BRIEF DESCRIPTION ( <i>Brief scope, size, cost, etc.</i> ) AND SPECIFIC ROLE <input checked="" type="checkbox"/> Check if project performed with current firm															
	<p>The following projects represent both vertical and horizontal construction examples where Kirby Hays served as <b>Project Manager</b> for project sites throughout California and Arizona. Relevant projects to the GO2 Yard Work project are asterisked in blue:</p> <table border="1"> <thead> <tr> <th>PROJECTS</th> <th>CLIENT</th> <th>VALUE</th> </tr> </thead> <tbody> <tr> <td>8033 - MECHANICAL BAR SCREEN, YUMA, AZ</td> <td>BUREAU OF REC.</td> <td>468,468.00</td> </tr> <tr> <td>8192 - <b>DB CDC YUMA *</b></td> <td>NAVFAC</td> <td>4,813,570.34</td> </tr> <tr> <td>8210 - <b>ACCESS CONTROL GATES *</b></td> <td>NAVFAC</td> <td>231,234.00</td> </tr> <tr> <td>8252 - B1591 MCAGCC 29 PALMS *</td> <td>NAVFAC</td> <td>766,242.77</td> </tr> </tbody> </table>		PROJECTS	CLIENT	VALUE	8033 - MECHANICAL BAR SCREEN, YUMA, AZ	BUREAU OF REC.	468,468.00	8192 - <b>DB CDC YUMA *</b>	NAVFAC	4,813,570.34	8210 - <b>ACCESS CONTROL GATES *</b>	NAVFAC	231,234.00	8252 - B1591 MCAGCC 29 PALMS *	NAVFAC
PROJECTS	CLIENT	VALUE														
8033 - MECHANICAL BAR SCREEN, YUMA, AZ	BUREAU OF REC.	468,468.00														
8192 - <b>DB CDC YUMA *</b>	NAVFAC	4,813,570.34														
8210 - <b>ACCESS CONTROL GATES *</b>	NAVFAC	231,234.00														
8252 - B1591 MCAGCC 29 PALMS *	NAVFAC	766,242.77														



	8257 - RESTORE B1175 DNITL CLNC , YUMA, AZ	USACE	641,987.07
	8287 - <b>DB</b> WHALE OVERLOOK	NPS	1,105,911.40
	8301 - JOSHUA TREE BOULDERS	NPS	78,910.00
	8306 - <b>BUILDING 333 PAVING</b> *	NAVFAC	223,418.00
	8309 - ROOFTOP PV Sys. B-1239 & 1235 *	NAVFAC	489,307.97
	9021 - CONSTRUCT RADAR TEST FACILITY *	NAVFAC	129,365.28
	9028 - REPLACE ALUMINUM LINE COTTONWOOD	NPS	186,453.95
	9078 - <b>ASPHALT</b> DELIVERY JOSHUA TREE	NPS	47,200.00
	9137 - <b>DB</b> VARIOUS SIDEWALKS	NAVFAC	465,557.00
	9158 - INSTALL PHOTOVOLTAIC SYSTEM *	NAVFAC	2,225,913.24
	9166 - <b>DB</b> AUTO SKILLS CTR B1083	NAVFAC	1,619,985.50
	9203 - RESURFACE COMPASS ROSE	NAVFAC	147,741.00
	9218 - YOSEMITE VOGELSANG HIGH SIERRA	NPS	378,163.05
	9224 - <b>DB</b> PHOTOVOLTAIC CARPORT *	NAVFAC	1,595,038.52
	9226 - <b>DB</b> SECURITY IMPROVEMENTS *	NAVFAC	489,008.00
	9238 - REPAIR POOL 1507	NAVFAC	1,634,569.23
	9239 - <b>DB</b> 3RD CEB ADMIN FACILITY *	NAVFAC	423,675.70
	9266 - <b>DB</b> CONSTRUCT BAND HALL	NAVFAC	839,401.89
	9270 - DRMO <b>PAVING AND STRIPING</b>	USACE	872,356.31
	10026 - SITE DEMO SAUGUS *	BLM	18,385.20
	10035 - <b>DB WASH RACK</b> *	NAVFAC	3,007,432.00
	10223 - <b>INSTL TRAFFIC CALMING SYSTEM</b> *	USAF	107,079.80
	10253 - <b>DB</b> WAREHOUSE MCAS YUMA	NAVFAC	843,903.00
	10312 - REPAIR TRAINING TANK B62517	NAVFAC	1,832,832.66
	(1) TITLE AND LOCATION ( <i>CITY AND STATE</i> )	(1) YEAR COMPLETED	
	<b>Yosemite Bridge and Site Improvement Construction</b> Yosemite National Park, CA	2009	
l.	(3) BRIEF DESCRIPTION ( <i>BRIEF SCOPE, SIZE, COST, ETC.</i> ) AND SPECIFIC ROLE <input checked="" type="checkbox"/> CHECK IF PROJECT PERFORMED WITH CURRENT FIRM		
	This project was for the <b>design</b> and <b>replacement</b> of the Yosemite Creek Bridge at Yosemite National Park, CA. The project included: demolition of existing bridge; install temporary creek crossing path; and placement of erosion control measures (riprap embankments; rock slope protection; filter fabric; native willows), new wood/steel bridge construction, excavation; new abutments and wingwalls; new footings; install bridge structural steel, bracing, and salvaged planks/guardrails; and install stone veneer, grade for paving; install base; install asphalt pavement; repair potholes; and fine grade site.  <b>Cost:</b> \$724K <b>Role:</b> Principal-In-Charge		
m.	(1) TITLE AND LOCATION ( <i>City and State</i> )	(2) YEAR COMPLETED	
	<b>Renovate Barracks Building 261</b> Ft. Irwin, CA	2007	



(3) BRIEF DESCRIPTION (*Brief scope, size, cost, etc.*) AND SPECIFIC ROLE

Check if project performed with current firm

This project was for an extensive renovation and modernization of the 3-story Barracks Buildings 261, Fort Irwin, CA. The scope of work included: new building systems: fire protection; HVAC; and minor electrical. The building exteriors included: **demolition**; doors; windows; paint; and ER film. The interior upgrades included: lighting; stairs; stairwells; sleeping rooms; 68 bathrooms; hard and suspended ceilings; hallways; common areas; new fixtures/equipment installation; restroom sinks; vanities and toilets; mop sink; flooring and baseboards; and furniture relocation and storage. The project required management of 11 subcontractors and simultaneous execution of renovations to barracks rooms; bathrooms; CQ office; day room; hallway telephone area; and laundry room renovation with new plumbing; installation of new washers, new dryers, and construction of a T.V. Room on the first floor.

**This project received an Outstanding performance evaluation rating.**

**Cost:** \$1.4M

**Role:** Quality Control Supervisor



NAME			ROLE IN THIS CONTRACT			YEARS EXPERIENCE	
<b>Jeff Geist</b>			President			a. TOTAL 43	b. WITH CURRENT FIRM 1
FIRM NAME AND LOCATION							
Hal Hays Construction Inc., Riverside, CA							
EDUCATION <i>(Degree, Specialization, Training &amp; Certification)</i>							
<ul style="list-style-type: none"> <li>▪ 43 Years of Industry Experience</li> <li>▪ OSHA 30 Hour Training Certificate</li> <li>▪ Metrolink Railway Worker 49CFR 214.345 Certified</li> <li>▪ UTC Pink Card Training</li> <li>▪ Fluent Knowledge of Building Codes, Federal, Military and COE Building Specifications</li> <li>▪ Oversight of Multiple Site Concurrent Operations</li> <li>▪ UTC Level III Training</li> <li>▪ UTC Awareness Trained</li> <li>▪ Construction Quality Management Training</li> <li>▪ Primavera P3/P6</li> <li>▪ Workplace Harassment Training</li> <li>▪ Management of over 200 Employees and numerous Subcontractors</li> </ul>							
OTHER PROFESSIONAL QUALIFICATIONS							
<p>Mr. Geist, <b>Corporate Executive</b>, is responsible for oversight of <b>project operations</b>, including: task order <b>estimation, development and strategic planning; construction operations planning; selection</b> of Project Managers and <b>design build team</b> members; coordination of <b>concurrent task</b> orders; budgeted versus actual <b>cost reviews; contract negotiations; supplemental</b> management support of Project Managers; and <b>technical</b> consultation to the project delivery team</p> <p><b>Software Skills:</b> MS Windows Professional, MS Office Suite, MS Outlook, Primavera CPM Scheduling</p> <p><b>Job Skills:</b> Company &amp; Project Management, Quality Control, Scheduling, Estimating, Logistics, and Safety Tasks</p> <p><b>Program Management Experience</b></p> <p>Throughout his career Mr. Geist has executed the role of VP/Operations Manager, and possesses professional qualifications and extensive experience such as:</p> <ul style="list-style-type: none"> <li>▪ Managing heavy civil construction projects exceeding <b>\$450 Million</b>.</li> <li>▪ Extensive experience in earthmoving, pipelines, railroad construction, HMA paving, large-scale mining operations, HMA plant construction &amp; management, aggregate plant construction &amp; management.</li> <li>▪ Design Build Manager for successful procurement of <b>\$275M I-15 Express Lanes, Corona / \$40M San Juan Channel, SJ Capistrano</b></li> <li>▪ Recent projects (since 2005): <ul style="list-style-type: none"> <li>▪ \$136M I-215 HOV GAP Closure Project, Colton</li> <li>▪ \$135M Perris Valley Line Metrolink Extension, Perris</li> <li>▪ \$91M I-10 Freeway HOV Lanes, Covina</li> <li>▪ \$126M Vulcan Materials Quarry Rehabilitation &amp; Expansion, Duarte</li> <li>▪ \$31M Newport Road Interchange, Menifee</li> <li>▪ \$43M Pier F Rail Expansion, Port of Long Beach</li> <li>▪ \$22M UPRR Rail Siding Expansion, Niland</li> <li>▪ \$72M SR-76 Widening, Fallbrook</li> <li>▪ \$23M Citrus Reservoir &amp; Pumping Plant, Redlands</li> <li>▪ \$21M Crafton Pump Station Expansion, Mentone</li> </ul> </li> </ul>							
EMPLOYMENT HISTORY							
02/17 - Present		Hal Hays Construction Inc., Riverside, CA				President	



NAME																					
NAME	ROLE IN THIS CONTRACT	YEARS EXPERIENCE																			
		a. TOTAL	b. WITH CURRENT FIRM																		
<b>Matt Goddard</b>	Corporate Scheduler	20	7																		
FIRM NAME AND LOCATION ( <i>City and State</i> ) Hal Hays Construction, Inc., Riverside, CA																					
EDUCATION ( <i>Degree, Specialization, Training &amp; Certification</i> ) <ul style="list-style-type: none"> <li>▪ 1996 Bachelor's Degree in Construction Engineering Management, Oregon State University, Corvallis, OR</li> <li>▪ 1996, Minor in Business, Oregon State University, Corvallis, OR</li> <li>▪ 1994, Associate's Degree in Mechanical Engineering, Lane Community College, Eugene, OR</li> <li>▪ Project Management Professional Certification</li> <li>▪ Primavera 5e Certified</li> <li>▪ Primavera 6 Certified</li> <li>▪ Workplace Harassment Training</li> <li>▪ Top Secret Security Clearance (inactive)</li> </ul>																					
OTHER PROFESSIONAL QUALIFICATIONS ( <i>Relevant</i> ) <p>Mr. Goddard has extensive Department of Defense, PUC, and government experience related to Design-Build, building construction, and heavy civil construction. With twenty years of scheduling experience, Mr. Goddard has developed, updated, and reported schedules for over 375 projects, including: site work; facility renovation and new construction of VA hospitals, Service Centers, offices, warehouses, hangars, dormitories and BEQ's; substations; and fire stations. He maintains specific experience in work areas, such as: Design-Build; Facilities; BMP implementation; demolition; heavy civil/earthwork; excavation and trenching; utility systems; asphalt paving; concrete paving; landscaping; striping and signage; traffic control measures; multi-site operations; and work on secured sites near critical assets.</p> <p><b>Software Skills:</b> MS Windows Professional; MS Office Suite; Primavera P3, P5e, and P6; and MS Project 97, 2000, and 2002</p> <p><b>Job Skills:</b> Master Scheduling; Project Management; and Reporting</p> <p>For the following projects, Mr. Goddard executed the role of Corporate Scheduler involving creating, revising, and submitting schedules within Primavera P6, including: baseline of original project schedule; coordination with on-site and off-site management staff for schedule updates; fragments of schedules for contract modification tracking; three-week look ahead; weekly schedule updates; and cost loading. Additional responsibilities include development of corporate scheduling policy and procedures, maintaining master schedule of all ongoing projects within the organization, and coordination with Estimating and Design Management Departments to develop proposal schedules.</p>																					
PREVIOUS EMPLOYERS <table style="width: 100%; border-collapse: collapse;"> <tr> <td style="width: 15%;">2011 - Present</td> <td style="width: 45%;">Hal Hays Construction, Inc., Riverside, CA</td> <td style="width: 40%;">Corporate Scheduler</td> </tr> <tr> <td>2007 - 2011</td> <td>Tepa Construction, Colorado Springs, CO</td> <td>Corporate Schedule Manager</td> </tr> <tr> <td>1999 - 2007</td> <td>DPR, Redwood City, CA</td> <td>Scheduler</td> </tr> <tr> <td>1997 - 1999</td> <td>ADP/Marshall, Inc., Greenville, NC</td> <td>Asst. Project Mgr./Scheduler</td> </tr> <tr> <td>1996 - 1997</td> <td>Marshall Company, East Providence, RI</td> <td>Field Engineer/Scheduler</td> </tr> <tr> <td>1996 - 1996</td> <td>HCMS, Portland, OR</td> <td>Scheduler</td> </tr> </table>				2011 - Present	Hal Hays Construction, Inc., Riverside, CA	Corporate Scheduler	2007 - 2011	Tepa Construction, Colorado Springs, CO	Corporate Schedule Manager	1999 - 2007	DPR, Redwood City, CA	Scheduler	1997 - 1999	ADP/Marshall, Inc., Greenville, NC	Asst. Project Mgr./Scheduler	1996 - 1997	Marshall Company, East Providence, RI	Field Engineer/Scheduler	1996 - 1996	HCMS, Portland, OR	Scheduler
2011 - Present	Hal Hays Construction, Inc., Riverside, CA	Corporate Scheduler																			
2007 - 2011	Tepa Construction, Colorado Springs, CO	Corporate Schedule Manager																			
1999 - 2007	DPR, Redwood City, CA	Scheduler																			
1997 - 1999	ADP/Marshall, Inc., Greenville, NC	Asst. Project Mgr./Scheduler																			
1996 - 1997	Marshall Company, East Providence, RI	Field Engineer/Scheduler																			
1996 - 1996	HCMS, Portland, OR	Scheduler																			



**List of Current/Ongoing Projects**

Project Name & Type of Work	Owner Name	Estimated Contract Completion Value (incl. change orders to date)	Percent Currently Complete	Estimated Completion Date
DB Operations Access Red Beach, General/Civil Construction	US Navy	\$15,999,405.04	26%	10-9-2018
DB Improve Intersections Civil Construction	US Navy	\$865,170.44	83%	03-09-2018 * on hold
DB San Jacinto Road Extension Civil Construction	US Navy	\$4,360,763	85%	02-24-2018 *on hold
Army Reserve Center Fresno General Construction	US Army	\$26,271,299.55	85%	10-9-2018
Beale Temporary Lodging Fac General Construction	US Army	\$16,610,995.28	60%	8-8-2018
Susanville CCC/HDSP Prison General Construction	Dept. of Correction & Rehab	\$27,300,350.00	75%	8-31-2018
Fresno WWTP Odor Control Wet Utility Construction	City of Fresno	\$8,430,354.25	90%	6-14-2018
Eureka Juvenile Hall General Construction	County of Humboldt	\$15,461,296.00	42%	8-29-2018
San Joaquin Fish Hatchery General/Wet Util. Const.	DGS CA	\$16,853,874.33	55%	11-18-2018
DVI Solid Cell Conversion General Construction	Dept. of Correctio & Rehab	\$8,323,138.00	45%	12-23-2018
Riverside Regional Water Plant Levee, Civil/Wet Util Const.	City of Riverside	\$3,194,063.00	60%	09-31-2018
Renovate Palm Springs Police Dept. General Construction	City of Palm Springs	\$4,228,679.09	65%	8-2-2018
DB Holabird Plant Backwash Wet Util. Construction	Golden State Water Co.	\$777,624.00	0%	08-27-2018 *in Design
Bakersfield Base Facility General Construction	SoCalGas	\$19,875,867.00	22%	3-7-2019
Northern Dist. Meter replacements, Wet Util. Constr	California America Water	\$441,911.00	44%	8-5-2018
Stockton Booster STA Sitewor Wet Util/Civil Construction	California Water Service Co.	\$1,751,784.15	0%	1-6-2019
Santa Rosa Fire Recovery Hydrants Replacement	California Water Service Co.	\$137,000.00	90%	8-31-2018
Demo Steel Water Tank Wet Util, Construction	California Water Service Co.	\$112,779.00	0%	10-1-2018
Intake 2 Spillway Modification Wet Util, Construction	SCE	\$354,410.00	0%	11-21-2018



**LIST OF COMPLETED PROJECTS EXPERIENCE**

<b>Project Name &amp; Type of Work</b>	<b>Owner Name</b>	<b>Contract Completion Value</b>	<b>Final Completion Date</b>
RCTC Rail Station Improvements/ Civil Construction	Riverside County Transportation	\$1,123,148.00	02/22/2018
SCE San Dieguito Wetlands/ Civil Construction	SCE	\$1,293,949.00	07/28/2017
El Campo Rd Water Main/ Wet Util. Civil Construction	Golden State Water Co.	\$850,288.60	12/30/2017
Elsinore Wash Rack and Site Improvements/ Civil Construction	Caltrans	\$1,802,701.00	11/17/2017
Ontario Police Headquarters Renovation/General Construction	City of Ontario	\$2,386,111.20	10/19/2017
Plant 11 Phase 2 Improvements/ Wet Util, Civil Construction	San Gabriel Valley Water Co.	\$619,600.60	01/10/2017
DB Repair Water Tank/Wet Utility Construction	US Navy	\$1,055,000.00	07/27/2015
DB Improve Intersections/ Civil Construction	US Navy	\$851,528.88	12/09/2016
DB Overhead Utilities Relocate/General Construction	US Army-Louisville	\$4,342,235.14	12/31/2016
DB Repair Area 52 Roads/Civil Construction	US Navy	\$1,564,025.83	12/20/2016
DB Replace Fire Main/ General Construction	US Navy	\$1,271,060.00	06/30/2015
DB Repair Recirculation Lines/General Construction	US Navy	\$1,190,495.00	12/03/2016
DB Repave Various Lots/Civil Construction	US Navy	\$1,838,948.00	12/15/2016
Repairs to Asphalt Parking/Civil Construction	US Navy	\$815,518.00	12/26/2015



RELEVANT PROJECTS		
a.	<p>(1) TITLE AND LOCATION (<i>City and State</i>)</p> <p><b>Design Build Railroad Operations Access Points, Red Beach</b> MCB Camp Pendleton, CA</p>	<p>(2) YEAR COMPLETED</p> <p>Present</p>
	<p>(3) BRIEF DESCRIPTION (<i>Brief scope, size, cost, etc.</i>) AND SPECIFIC ROLE <input type="checkbox"/> Check if project performed with current firm</p> <p>This <b>Design Build</b> project is to design and reconstruct of railroad bridge and roadways at MCB Camp Pendleton, CA for NAVFAC SW.</p> <p>The scope of work included: SWPPP and BMP implementation; <b>demolition</b>; heavy civil and grading; clear and grub; earthwork; roadway paving; drainage infrastructure; railroad improvements; bridge structure; soldier pile wall.</p> <p><b>Cost: \$15.9M Role: Scheduler</b></p>	
b.	<p>(1) TITLE AND LOCATION (<i>City and State</i>)</p> <p><b>Design Build P-111 Armory</b> MCB Camp Pendleton, CA</p>	<p>(2) YEAR COMPLETED</p> <p>2017</p>
	<p>(3) BRIEF DESCRIPTION (<i>Brief scope, size, cost, etc.</i>) AND SPECIFIC ROLE <input type="checkbox"/> Check if project performed with current firm</p> <p>This <b>Design Build</b> project is for the design and construction of the ground up armory building located at MCB Camp Pendleton, CA for NAVFAC SW.</p> <p>The scope of work included: SWPPP and BMP implementation; <b>demolition</b>; heavy civil and grading; clear and grub; underground storm drain system; structural concrete; masonry; casework; solid surface countertops; insulation; doors/ Frames &amp; hardware; vault doors; windows; metal stud framing/ gypsum board; wire mesh partitions; roofing; tile; acoustical ceiling; flooring; paint &amp; wall covering; high performance coatings; signage; toilet accessories; metal lockers; entrance mats; fire extinguishers; fire suppression; plumbing; HVAC; electrical; communications; electronic safety &amp; security; earthwork; bituminous paving; aggregate base course; pavement markings; high security fencing; planting; water distribution; natural gas &amp; liquid petroleum piping; sanitary sewers; lift stations; force mains, sewer &amp; storm drains.</p> <p><b>Cost: \$4.5M Role: Scheduler</b></p>	
c.	<p>(1) TITLE AND LOCATION (<i>City and State</i>)</p> <p><b>Design Build Repair Cristianitos Road</b> MCB Camp Pendleton, CA</p>	<p>(2) YEAR COMPLETED</p> <p>2015</p>
	<p>(3) BRIEF DESCRIPTION (<i>Brief scope, size, cost, etc.</i>) AND SPECIFIC ROLE <input type="checkbox"/> Check if project performed with current firm</p> <p>This <b>Design Build</b> project is to design and reconstruct roadways and provide erosion control/storm drain improvements along Cristianitos Road in at MCB Camp Pendleton, CA for NAVFAC SW.</p> <p>The scope of work included: SWPPP and BMP implementation; <b>demolition</b>; heavy civil and grading; clear and grub; underground storm drain system (headwalls, rip-rap, culverts, and piping); sub-base preparation; aggregate base; asphalt pavement; retaining walls; guard rails; signage and striping; and traffic control measures.</p> <p><b>Cost: \$788K Role: Scheduler</b></p>	



	(1) TITLE AND LOCATION ( <i>City and State</i> )	(2) YEAR COMPLETED
	<b>Design Build Asphalt Repair Runway 14/32</b> Naval Air Weapons Station, Chino Lake, CA	2014
d.	(3) BRIEF DESCRIPTION ( <i>Brief scope, size, cost, etc.</i> ) AND SPECIFIC ROLE <input checked="" type="checkbox"/> Check if project performed with current firm	
	<p>This Design Build project was for the design and construction of asphalt repairs of runway 14/32 at the Naval Air Weapons Station, Chino Lake, CA for NAVFAC SW. The scope of work includes: <b>demolition</b>; excavation; grading; A/C paving; pavement repairs; preparing sub-grade; clearing and grubbing; concrete work; striping and signage; traffic control; SWPPP and BMP implementation; and <b>underground utilities</b>.</p> <p><b>Cost: \$7.3M    Role: Scheduler</b></p>	
	(1) TITLE AND LOCATION ( <i>City and State</i> )	(2) YEAR COMPLETED
	<b>DB Repair Wastewater System at TAPS 1, 2 &amp; 3</b> Marine Corp Base, Camp Pendleton, CA	2014
e.	(3) BRIEF DESCRIPTION ( <i>Brief scope, size, cost, etc.</i> ) AND SPECIFIC ROLE <input checked="" type="checkbox"/> Check if project performed with current firm	
	<p>This <b>Design-Build</b> project is for the repairs to the wastewater system at TAPS 1, 2, and 3 at the Marine Corp Base, Camp Pendleton, CA for NAVFAC SW. The scope of work includes: <b>demolition</b>; BMP implementation; trenching and excavation; sewer systems; electrical systems; SCADA monitoring system; <b>distribution piping and system components</b> (tanks, pumps, air-gap system, high pressure spray and hoses, hose bibs, shut-off valves, and floor drains); environmental restrictions; and completion of work while maintaining operational utility systems.</p> <p><b>Cost: \$381K    Role: Scheduler</b></p>	
	(1) TITLE AND LOCATION ( <i>City and State</i> )	(2) YEAR COMPLETED
	<b>DB Renovate 3 Buildings and Parking Lot</b> Air Force, Plant 42, Palmdale, CA	2014
f.	(3) BRIEF DESCRIPTION ( <i>Brief scope, size, cost, etc.</i> ) AND SPECIFIC ROLE <input checked="" type="checkbox"/> Check if project performed with current firm	
	<p>This <b>Design-Build</b> project is to renovate Buildings 552, 553, and 560 as well as construct a new parking lot at Air Force Plant 42, Palmdale, CA for USACE. The renovation of Building 552, a single story masonry structure, approximately 7,101 SF, included the removal of existing interior finishes; abatement of hazardous materials; structural upgrades to existing masonry walls for code compliance; reconfiguration of interior spaces for ABA compliance; and creation of open-plan office arrangements.</p> <p>The renovation of Building 553 included: a single story masonry structure, approximately 5,345 SF; removal of existing interior finishes; abatement of hazardous materials; structural upgrades to existing masonry walls for code compliance; reconfiguration of interior spaces for administrative and training offices; a guard assembly and resources room; <b>restrooms</b>; locker/change rooms; a BDOC; and a masonry addition to house mechanical, electrical, and telecommunications equipment; and provide space for storage of security items.</p> <p>The renovation of Building 560 included: a two story pre-engineered metal building, approximately 5,782 SF; removal of interior partition walls; reconfiguration of the first floor <b>restrooms</b> to comply with ABA requirements; installation of new convenience centers; replacement of floor <b>finishes</b>; suspended panel ceilings; and repairs to the existing vehicle parking area adjacent to Building 560 to provide ABA required accessible routing. The new parking lot will be located south of Building 560 and east of the</p>	



	<p>AF Plant 42 Control Tower. The parking lot shall provide approximately 115 parking stalls, including ABA compliant and motorcycle stalls to serve Building 553's existing fire station and the control tower.</p> <p><b>Cost:</b> \$5.5M      <b>Role:</b> Scheduler</p>	
9.	<p>(1) TITLE AND LOCATION (<i>City and State</i>)</p> <p><b>DB Replace Fire Sprinklers at Buildings BB1A, BB1B, BB1C, 2, 3, 4, 14, 170, 403, 405, and 632, Phase 3</b> Marine Corps Logistics Base, Nebo and Yermo Annex, Barstow, CA</p>	<p>(2) YEAR COMPLETED</p> <p>2013</p>
	<p>(3) BRIEF DESCRIPTION (<i>Brief scope, size, cost, etc.</i>) AND SPECIFIC ROLE <input checked="" type="checkbox"/> Check if project performed with current firm</p> <p>This <b>Design Build</b> project was for the design and replacement of existing failed dry-pipe fire sprinkler systems at Buildings BB1A, BB1B, BB1C, 2, 3, 4, 14, 170, 403, 405, and 632 at the Marine Corps Logistics Base, Barstow, CA for NAVFAC SW. The scope of work included: BMP implementation; excavation and trenching; <b>demolition and removal of existing dry-pipe</b> fire sprinkler systems; <b>new required piping</b>; sprinkler heads; alarm valve; tamper and flow switches; double-check assembly backflow preventers (existing backflow preventers to remain); underground <b>water system upgrades (distribution piping, backflow preventers, and fire department connections)</b>; and connections to existing fire alarm systems.</p> <p><b>Cost:</b> \$8.3M      <b>Role:</b> Scheduler</p>	
h.	<p>(1) TITLE AND LOCATION (<i>City and State</i>)</p> <p><b>Design-Build Repair Aqueous Film Forming Foam (AFFF) Storage Systems</b> Camp Pendleton, CA</p>	<p>(2) YEAR COMPLETED</p> <p>2013</p>
	<p>(3) BRIEF DESCRIPTION (<i>Brief scope, size, cost, etc.</i>) AND SPECIFIC ROLE <input type="checkbox"/> Check if project performed with current firm</p> <p>This <b>Design Build</b> project was for the design of repairs to the Aqueous Film Forming Foam (AFFF) Underground Storage Tank Systems at the Marine Corps Base, Camp Pendleton, CA for NAVFAC SW. The scope of work includes: repair leaks; cap all cross connections; dewater and conduct sump testing to identify leaks; install tank and space liquid detection system; remove and replace manhole units; install cleanouts for maintenance purposes; electrical; <b>underground utilities</b>; provide electrical support tank and interstitial space liquid-tight caps on all 4-inch risers of each tank; confirm that any surface drainage into the well completion units will drain into the tank, hold pea gravel backfill and not build up and overflow into the tanks; and adherence to environmental restrictions.</p> <p><b>Cost:</b> \$1M      <b>Role:</b> Scheduler</p>	
i.	<p>(1) TITLE AND LOCATION (<i>City and State</i>)</p> <p><b>Naval Exchange (NEX) Renovations</b> Naval Base Point Mugu, CA</p>	<p>(2) YEAR COMPLETED</p> <p>2012</p>
	<p>(3) BRIEF DESCRIPTION (<i>Brief scope, size, cost, etc.</i>) AND SPECIFIC ROLE <input checked="" type="checkbox"/> Check if project performed with current firm</p> <p>This <b>Design-Build</b> project was for exterior renovation of the NEX complex building 16 at the Naval Base Ventura County, Point Mugu, CA for NAVFAC SW. The Naval Exchange complex at Point Mugu contains retail, restaurant, sports training, and Morale, Welfare and Recreation gymnasium space for military and DOD employees. The scope of work included: hazardous material abatement; <b>demolition</b>; replacement of the retail space façade; new storefront; doors; louvers; stucco exterior finish; replacement of the existing covered walkway; remove and repair or replace exterior and landscape</p>	



	lighting; storm water drainage and downspouts; storm water management; landscaping; irrigation system; and signage. This project received an Outstanding performance evaluation rating.	
	<b>Cost:</b> \$1.6M <b>Role:</b> Scheduler	
	(1) TITLE AND LOCATION ( <i>City and State</i> )	(2) YEAR COMPLETED
	<b>DB Building Envelope Improvements - Multiple Facilities</b> Travis AFB, CA	2012
j.	(3) BRIEF DESCRIPTION ( <i>Brief scope, size, cost, etc.</i> ) AND SPECIFIC ROLE <input checked="" type="checkbox"/> Check if project performed with current firm This <b>Design-Build</b> project was for the design and construction of building envelope improvements and upgrade to the energy efficiency of Multiple Facilities at Travis Air Force Base in Fairfield, CA for NAVFAC SW. The scope of work included: upgrading the attic or ceiling insulation; weatherizing around doors, windows, and other openings requiring a seal; installation of Dual Reflective Solar Control Glazing Films; provide engineered synthetic catalyst technology additive to refrigerant in HVAC units; thermal imaging analysis of building to identify areas that require repair; insulation, caulking, weather stripping, and leak repair of areas identified by thermal imaging analysis; caulk and seal air leaks where <b>plumbing</b> , ducting, or electrical wiring penetrated through walls, floors, and ceilings; replace existing door bottoms and thresholds with pliable sealing and gaskets where appropriate; repair/install insulation in attic spaces and above dropped ceilings as appropriate; weather-strip door jams; install window film; install Refrigerant Synthetic Refrigerant Catalyst in all air conditioners. <b>Cost:</b> \$791K <b>Role:</b> Scheduler	
	(1) TITLE AND LOCATION ( <i>City and State</i> )	(2) YEAR COMPLETED
	<b>DB Replace Pavement, Building No. 11031</b> Naval Air Weapons Station, China Lake, CA	2012
k.	(3) BRIEF DESCRIPTION ( <i>Brief scope, size, cost, etc.</i> ) AND SPECIFIC ROLE <input checked="" type="checkbox"/> Check if project performed with current firm This <b>Design-Build</b> project was for the design, construction, and replacement of pavement at building 11031 at Naval Air Weapons Station, China Lake, CA for NAVFAC SW. The scope of work included: replace deteriorated asphalt parking lot; approach driveways; and road surface around Building 11031, located in the CLPL Main site area. The scope of work also included: pulverizing existing paved areas; grade and compact to provide appropriate base material; lay new asphalt pavement; finish grade shall be sloped for proper drainage; stripe all roads and parking lots accordingly; and provide ADA compliant pedestrian pathways between building 11031, 11093, 11094, and 11030. <b>Cost:</b> \$387K <b>Role:</b> Scheduler	
	(1) TITLE AND LOCATION ( <i>City and State</i> )	(2) YEAR COMPLETED
	<b>DB Renovations of the 31st SRG Building Improvements - Bldg 1157, 1158 and 1161</b> Naval Base Ventura County, Port Hueneme, CA	2011
l.	(3) BRIEF DESCRIPTION ( <i>Brief scope, size, cost, etc.</i> ) AND SPECIFIC ROLE <input checked="" type="checkbox"/> Check if project performed with current firm This <b>Design-Build</b> project was for the design, construction, and renovation of one existing building and the maintenance of two others occupied by the 31st Seabee Readiness Group (SRG) located at Port Hueneme Naval Base, Ventura County, CA for NAVFAC SW. Scope of work included: rust/hole repair or replacement of the exterior closure; painting the exterior closure; replacement of exterior	



	windows; installation of CAC card secured door entry systems; <b>bathroom renovation and upgrades</b> ; HVAC; <b>mechanical</b> and electrical upgrades; <b>associated demolition</b> ; site work; and <b>utilities work</b> .  <b>Cost:</b> \$1.4M <b>Role:</b> Scheduler	
	(1) TITLE AND LOCATION ( <i>City and State</i> )  <b>MI COF</b> Fort Carson, CO	(2) YEAR COMPLETED  2011
m	(3) BRIEF DESCRIPTION ( <i>Brief scope, size, cost, etc.</i> ) AND SPECIFIC ROLE <input type="checkbox"/> Check if project performed with current firm  This <b>Design-Build</b> project was for the design and construction of a new ground up facility for warehousing and office space at Fort Carson, CO for the U.S. Army Corps of Engineers. The scope of work included: excavation and grading; underground utilities; concrete foundations; site work with hardstand parking lot; landscaping; structural masonry; framing; electrical; <b>plumbing</b> ; <b>mechanical</b> ; insulation; drywall; painting; flooring and carpeting; doors and hardware; windows; interior finishes; and restroom facilities.  <b>Cost:</b> \$15M <b>Role:</b> Corporate Schedule Manager	



NAME			
NAME	ROLE IN THIS CONTRACT	YEARS EXPERIENCE	
		a. TOTAL	b. WITH CURRENT FIRM
<b>Tom Bailey</b>	<b>Operations Manager, Northern California</b>	35	7
FIRM NAME AND LOCATION ( <i>City and State</i> )			
Hal Hays Construction, Inc., Riverside, CA			
EDUCATION ( <i>Degree, Specialization, Training &amp; Certification</i> )			
<ul style="list-style-type: none"> <li>▪ 1981 Bachelor of Science in Architecture, California State Polytechnic University, San Luis Obispo, CA</li> <li>▪ California Contractors License               <ul style="list-style-type: none"> <li>-Class A - General Engineering</li> <li>-Class B - General Building</li> </ul> </li> <li>▪ OSHA 30-Hour Certificate</li> <li>▪ Asbestos Abatement Certificate</li> <li>▪ Hazardous Substance Removal Certificate</li> </ul>			
OTHER PROFESSIONAL QUALIFICATIONS ( <i>Relevant</i> )			
<p>Mr. Bailey has extensive Department of Defense and government experience related to design build, building construction and heavy civil construction. He has extensive experience with estimating, bid submission, and project management of diverse types of public works construction. He maintains specific experience in this project's work areas, such as: Design Build; demolition; underground utilities; paving operations; site restoration; detailed phasing and coordination; traffic control; and work on active military sites.</p> <p><b>Software Skills:</b> MS Windows Professional, MS Office Suite, MS Outlook, Primavera P3, Primavera SureTrak Project Management, and Primavera CPM Scheduling</p> <p><b>Job Skills:</b> Program/Project Mgmt., Estimating, Quality Control, Scheduling, and Safety Tasks</p> <p>For the following projects, Mr. Bailey executed the role of Project/Design Build Manager, including: coordinating meetings and negotiations; recommendation of design and project changes to provide the client the best value for their project; provision of technical oversight for construction start up and testing; implementing subcontracts and purchase orders; and oversight of subcontractor's, supplier's and manufacturer's scheduling. Additional responsibilities include conducting and supervising on-site management staff, assisting in technical submittal reviews, and on-site inspections.</p>			
PREVIOUS EMPLOYERS			
2011 - Present	Hal Hays Construction, Inc., Riverside, CA	Operations Mgr., Northern Ca Design Manager/ Project Mgr.	
2010 - 2011	Erick Ammon, Inc., Anderson, CA	Project Manager/Estimator	
1994 - 2010	Tebcon, Inc., Shingle Springs, CA	President	
1991 - 1994	Spieß Construction Co., Inc., Santa Maria, CA	Sr. Project Manager/Chief Estimator	
1989 - 1991	Kleinfelder, Inc., San Diego, CA	Manager Construction Services	
1981 - 1989	Spieß Construction Co., Inc., Santa Maria, CA	Project Manager/Estimator	



### List of Current/Ongoing Projects

Project Name & Type of Work	Owner Name	Estimated Contract Completion Value (incl. change orders to date)	Percent Currently Complete	Estimated Completion Date
DB Operations Access Red Beach, General/Civil Construction	US Navy	\$15,999,405.04	26%	10-9-2018
DB Improve Intersections Civil Construction	US Navy	\$865,170.44	83%	03-09-2018 * on hold
DB San Jacinto Road Extension Civil Construction	US Navy	\$4,360,763	85%	02-24-2018 *on hold
Army Reserve Center Fresno General Construction	US Army	\$26,271,299.55	85%	10-9-2018
Beale Temporary Lodging Facility General Construction	US Army	\$16,610,995.28	60%	8-8-2018
Susanville CCC/HDSP Prison General Construction	Dept. of Correction & Rehab	\$27,300,350.00	75%	8-31-2018
Fresno WWTP Odor Control Wet Utility Construction	City of Fresno	\$8,430,354.25	90%	6-14-2018
Eureka Juvenile Hall General Construction	County of Humboldt	\$15,461,296.00	42%	8-29-2018
San Joaquin Fish Hatchery General/Wet Util. Const.	DGS CA	\$16,853,874.33	55%	11-18-2018
DVI Solid Cell Conversion General Construction	Dept. of Correctio & Rehab	\$8,323,138.00	45%	12-23-2018
Riverside Regional Water Plant Levee, Civil/Wet Util Const.	City of Riverside	\$3,194,063.00	60%	09-31-2018
Renovate Palm Springs Police Dept. General Construction	City of Palm Springs	\$4,228,679.09	65%	8-2-2018
DB Holabird Plant Backwash Wet Util. Construction	Golden State Water Co.	\$777,624.00	0%	08-27-2018 *in Design
Bakersfield Base Facility General Construction	SoCalGas	\$19,875,867.00	22%	3-7-2019
Northern Dist. Meter replacements, Wet Util. Construction	California America Water	\$441,911.00	44%	8-5-2018
Stockton Booster STA Sitework Wet Util/Civil Construction	California Water Service Co.	\$1,751,784.15	0%	1-6-2019
Santa Rosa Fire Recovery Hydrants Replacement	California Water Service Co.	\$137,000.00	90%	8-31-2018
Demo Steel Water Tank Wet Util, Construction	California Water Service Co.	\$112,779.00	0%	10-1-2018

RELEVANT PROJECTS		
a.	(1) TITLE AND LOCATION ( <i>City and State</i> ) <b>Design Build Delta Taxiway Repairs</b> NAS Fallon, NV	(2) YEAR COMPLETED 2015
	(3) BRIEF DESCRIPTION ( <i>Brief scope, size, cost, etc.</i> ) AND SPECIFIC ROLE <input checked="" type="checkbox"/> Check if project performed with current firm This Design Build project was for the design and construction of repairs to Delta Taxiway between Runway 7/25 and MAT 7 at Naval Air Station Fallon, NV for NAVFAC SW. The scope of work included: pavement milling; crack repair; joint repair; slurry sealing; pavement markings; and FOD control measures. Detailed coordination and scheduling was required to perform work at this active airfield. <b>Cost: \$318K                      Role: Design Build Project Manager/Estimator</b>	
b.	(1) TITLE AND LOCATION ( <i>City and State</i> ) <b>Design Build Hayman Igloo</b> Hill Air Force Base, UT	(2) YEAR COMPLETED 2015
	(3) BRIEF DESCRIPTION ( <i>Brief scope, size, cost, etc.</i> ) AND SPECIFIC ROLE <input checked="" type="checkbox"/> Check if project performed with current firm This Design Build project was for the design and construction of a 26 FT x 80 FT earth covered Hayman Igloo at Hill Air Force Base, UT for USACE. The scope of work included: construction of a new earth covered reinforced concrete Hayman Igloo Modular Storage Magazine (MSM) capable of storing 150,000 pounds of Hazard Division 1.1 munitions; stripping vegetation, access roadways; <b>reinforced concrete aprons; utilities; site improvements; and communications support.</b> <b>Cost: \$1M                      Role: Design Build Project Manager/Estimator</b>	
c.	(1) TITLE AND LOCATION ( <i>City and State</i> ) <b>Design Build Fire Alarm Reporting System</b> MOTCO, Concord, CA	(2) YEAR COMPLETED 2014
	(3) BRIEF DESCRIPTION ( <i>Brief scope, size, cost, etc.</i> ) AND SPECIFIC ROLE <input checked="" type="checkbox"/> Check if project performed with current firm This Design Build project provided design and construct for replacement of the existing fire alarm and fire alarm reporting system in selected building at MOTCO in Concord, CA for the US Army Corps of Engineers. The project scope of work included: UXO Plan and monitoring; lead and asbestos abatement; <b>demolition; excavation and trenching; concrete road repairs; communication manholes; concrete duct banks; conduit; fiber optic cabling; facility fire alarm and fire alarm report systems; electrical connections; and interior repairs.</b> <b>Cost: \$1.8M                      Role: Design Build Project Manager/Estimator</b>	
d.	(1) TITLE AND LOCATION ( <i>City and State</i> ) <b>Design Build Replace Two Sewage Lift Stations</b> MOTCO, Concord, CA	(2) YEAR COMPLETED 2014
	(3) BRIEF DESCRIPTION ( <i>Brief scope, size, cost, etc.</i> ) AND SPECIFIC ROLE <input checked="" type="checkbox"/> Check if project performed with current firm This Design Build project provided to design and construct for replacement of two sewage lift stations at MOTCO in Concord, CA for the US Army Corps of Engineers. Work took place in two locations, including the 'tidal side' of the base less than a mile from Suisun Bay, requiring continuous water removal for safe operations. The project scope of work included: UXO Plan and monitoring; <b>excavation; crushed rock foundations; crane work; pre-cast wet and dry well structure placement; electrical; plumbing; pumps; and piping.</b> <b>Cost: \$2.0M                      Role: Design Build Project Manager/Estimator</b>	

	(1) TITLE AND LOCATION ( <i>City and State</i> )	(2) YEAR COMPLETED
	<b>Construct A Bypass Road Around Taxiway Mike</b> Travis AFB, Fairfield, CA	2013
e.	(3) BRIEF DESCRIPTION ( <i>Brief scope, size, cost, etc.</i> ) AND SPECIFIC ROLE <input checked="" type="checkbox"/> Check if project performed with current firm <p>This project was for the construction of a bypass road around Taxiway Mike at Travis Air Force Base in Fairfield, CA for NAVFAC Southwest. The project consists of constructing and relocating perimeter road from W Street to south of the existing south gate facility with an <b>A/C pavement, travel lanes</b> and unpaved shoulders. The scope of work included: <b>demolition to include the removal, grinding, and pulverizing portions of the existing A/C pavement; excavation and compaction of sub-grade; install and compact base material; poured-in-place concrete</b>; install joint sealer in all control joints; install pavement striping; signage; traffic control measures; SWPPP and BMP implementations; demolition of existing fencing; construction of new fencing; construction of a water line to near the existing south gate facility; <b>underground conduit, street lighting, and reconstruction of pavement</b> adjacent to the existing south gate facility.</p> <p><b>Cost: \$5.7M      Role: Project Manager/Estimator</b></p>	
	(1) TITLE AND LOCATION ( <i>City and State</i> )	(2) YEAR COMPLETED
	<b>Design Build Eagle Lake Sewer Ponds</b> Lassen National Forest, CA	2012
f.	(3) BRIEF DESCRIPTION ( <i>Brief scope, size, cost, etc.</i> ) AND SPECIFIC ROLE <input type="checkbox"/> Check if project performed with current firm <p>This Design Build project for the design and construction of Eagle Lake Sewer Ponds at Lassen National Forest, CA for National Park Service. The scope of work included: the development and implementation of an upgrade to the existing Eagle Lake Waste Water Treatment Plant (WWTP) by enhancing the biological treatment process and functionality. This project included electrical and mechanical components.</p> <p><b>Cost: \$4.9M      Role: Design-Build Project Manager/Estimator</b></p>	
	(1) TITLE AND LOCATION ( <i>City and State</i> )	(2) YEAR COMPLETED
	<b>Water Storage Tank, Boulder Beach, NV</b> Lake Mead Recreation Area, NV	2011
g.	(3) BRIEF DESCRIPTION ( <i>Brief scope, size, cost, etc.</i> ) AND SPECIFIC ROLE <input type="checkbox"/> Check if project performed with current firm <p>This project was for the construction of a new water storage tank at Boulder Beach located in the Lake Mead Recreational Area, NV for the National Park Service. The purpose of this project was to demolish the existing 2,000,000 gallon painted steel tank and replace with the construction of a fully operational 300,000 gallon stained concrete tank. The scope of work included: the replacement of the pump house roof; installation of a circulation pump and internal sprayer; installation of an altitude valve and valve vault; installation of controls associated with the water tank; installation of pipe and valves; and installation of water meter on the tank outlet.</p> <p><b>Cost: \$1.3M      Role: Project Manager/Estimator</b></p>	
	(1) TITLE AND LOCATION ( <i>City and State</i> )	(2) YEAR COMPLETED
	<b>Whiskeytown Lake Temperature Curtain</b> Whiskeytown Lake National Recreation Area, CA	2011
h.	(3) BRIEF DESCRIPTION ( <i>Brief scope, size, cost, etc.</i> ) AND SPECIFIC ROLE <input type="checkbox"/> Check if project performed with current firm <p>This project was for the complete replacement of temperature curtains for the Whiskeytown Lake located in the Whiskeytown Lake National Recreation Area, CA for the Bureau of Reclamation. The</p>	

	<p>scope of work included: removal of the following existing equipment from site: curtain fabric; lower boom weighted tanks; air hoses; and sand socks; fabrication and installation of: a new curtain fabric; approximately 2,400 FT long, conforming to the contours of the reservoir from shore line to shore line, up to 110 FT deep; floating vertically from the reservoir maximum water surface elevation of 1,210 FT and surrounding the entrance to the Spring Creek Conduit Intake Structure, and all chains; wire rope, cables and other hardware required for the new curtain fabric and connection to the existing anchor system.</p> <p><b>Cost: \$3M</b>                      <b>Role: Design Manager/Estimator</b></p>	
i.	(1) TITLE AND LOCATION ( <i>City and State</i> )	(2) YEAR COMPLETED
	<p><b>NPI Water Treatment Upgrades &amp; Outfall Phase 2</b> Olympic National Park, Port Angeles, WA</p>	2011
	<p>(3) BRIEF DESCRIPTION (<i>Brief scope, size, cost, etc.</i>) AND SPECIFIC ROLE    <input type="checkbox"/> Check if project performed with current firm</p> <p>This project was for water treatment upgrades at mill: project to protect Nippon Paper Industries (NPI) water supply from increased sediment levels expected during removal of Elwha River Dams located at Olympic National Park, Port Angeles, WA for the National Park Service. The scope of work included: completion of a new outfall pipe to improve dispersion of sediment from the Nippon paper mill's incoming water treatment process; improvements to clarifiers and the addition of chemical feed capability for iron; and manganese removal from water going to the plant.</p> <p><b>Cost: \$4M</b>                      <b>Role: Project Manager/Estimator</b></p>	
j.	(1) TITLE AND LOCATION ( <i>City and State</i> )	(2) YEAR COMPLETED
	<p><b>Cedar Grove Employee Housing Rehabilitation</b> Kings Canyon National Park, CA</p>	2011
	<p>(3) BRIEF DESCRIPTION (<i>Brief scope, size, cost, etc.</i>) AND SPECIFIC ROLE    <input type="checkbox"/> Check if project performed with current firm</p> <p>The project was for the rehabilitation of the Cedar Grove employee housing, located in Cedar Grove Concessionaire Housing, Cedar Grove, Kings Canyon National Park, CA, for the National Park Service. The scope of work included: the construction of 13 trailer pads; including demolition/abandonment of existing utilities and installation of new utilities: (approximately 1800 LF of new water line; approximately 1600 LF of new gravity sewer pipelines, services and manholes; approximately 2500 LF of <b>underground duct bank</b> &amp; communication cabling for phone; 1000 gallon propane tank with fueling station; approximately 5200 LF of 220/240 electrical; site preparation; demolition of existing utilities and 3 hard sided trailer; and installation of 13 RV service pedestals.</p> <p><b>Cost: \$835K</b>                      <b>Role: Project Manager/Estimator</b></p>	
k.	(1) TITLE AND LOCATION ( <i>City and State</i> )	(2) YEAR COMPLETED
	<p><b>Bizz Johnson Trail Tunnel Repair</b> Lassen National Forest, CA</p>	2010
	<p>(3) BRIEF DESCRIPTION (<i>Brief scope, size, cost, etc.</i>) AND SPECIFIC ROLE    <input type="checkbox"/> Check if project performed with current firm</p> <p>This project was for the repair and improvements of the Bizz Johnson Trail Tunnels located in the Lassen National Forest, CA for the Federal Highway Administration. The scope of work included: portal concrete repair including contact grouting through tunnel ceiling; surface sealing of cracks; and epoxy injection of cracks; timber tunnel repair; including cribbing, blocking, lagging, and reattachment of various timber support members; rock scaling of all exposed rock surfaces within tunnel; <b>concrete</b> scaling of all loose <b>concrete</b> within tunnel portals; and <b>grading tunnel approaches</b> and trail surfaces.</p> <p><b>Cost: \$413K</b>                      <b>Role: Project Manager</b></p>	



NAME			
NAME	ROLE IN THIS CONTRACT	YEARS EXPERIENCE	
		a. TOTAL	b. WITH CURRENT FIRM
Jerry Neuman	General Superintendent	27	15
FIRM NAME AND LOCATION ( <i>City and State</i> )			
Hal Hays Construction, Inc., Riverside, CA			
EDUCATION ( <i>Degree, Specialization, Training &amp; Certification</i> )			
<ul style="list-style-type: none"> <li>▪ 1987 Universal Technical Institute, Phoenix AZ, Occupational Associate Degree</li> <li>▪ 1986 Big Bear High, Big Bear Lake, CA</li> <li>▪ 2012 EM 385-1-1 40-Hour</li> <li>▪ OSHA 30-Hour Certificate</li> <li>▪ OSHA 10-Hour Certificate</li> <li>▪ 2014 CPR &amp; First Aid Training</li> <li>▪ Subcontractor &amp; Site Safety Management Training</li> <li>▪ SureTrak Certified</li> <li>▪ Contractor Fire Line Safety Training</li> <li>▪ Emergency Equipment Operator Certified</li> <li>▪ Forestry Safety &amp; Operational Training</li> <li>▪ The Competent Person Training</li> <li>▪ Confined Space Entry Training</li> <li>▪ Excavation &amp; Trenching Training</li> <li>▪ Fall Protection Training</li> <li>▪ 2012 Aerial Lift Training</li> <li>▪ 2012 All Terrain Powered Industrial Truck Training</li> <li>▪ Powder Actuated Tools Training</li> <li>▪ 40-Hour Bid-Well Service School Safe Operation &amp; Maintenance Bid-Well 6500</li> <li>▪ Dust Control Training</li> </ul>			
OTHER PROFESSIONAL QUALIFICATION			
<p>Mr. Neuman has experience related to <b>underground wet utilities</b> (including distribution piping, valves, and connections), <b>Design-Build facility improvements and civil construction</b>. He has project experience specific to work areas such as: <b>demolition; earthwork; grading; excavation and trenching; concrete structures, paving; traffic control measures;</b> and Department of Defense work on military sites.</p> <p><b>Software Skills:</b> MS Windows, Outlook, and SureTrak</p> <p><b>Job Skills:</b> Superintendent/SSHO/Quality Control, Earthwork, and Safety Tasks</p> <p>For the following projects, Mr. Neuman executed the role of General Superintendent, including: Program-wide coordinating meetings and negotiations; recommendation of design and project changes to provide the client the best value for their project; provision of technical oversight and program-wide resource management including project construction methods consultant, program planning for staffing, scheduling, logistics, and project resources, technical consultation with A/E and subcontractors, safety and quality management consultation with project teams. Additional responsibilities include conducting and supervising on-site management staff, assisting in technical submittal reviews, and on-site inspections.</p>			
2017 – PRESENT	HAL HAYS CONSTRUCTION, INC., RIVERSIDE, CA	GENERAL SUPERINTENDENT	
2015 - 2017	STRONGHOLD ENGINEERING	SUPERINTENDENT	
2003 - 2015	HAL HAYS CONSTRUCTION, INC., RIVERSIDE, CA	GENERAL SUPERINTENDENT	
2001 - 2003	BEAR VALLEY PAVING, BIG BEAR LAKE, CA	SUPERINTENDENT/HEAVY EQUIPMENT OPERATOR	
1998 - 2001	AJ ACOSTA COMPANY, BIG BEAR LAKE, CA	SUPERINTENDENT/HEAVY EQUIPMENT OPERATOR	
1988 - 1998	CEDAR LAKE CAMP, BIG BEAR LAKE, CA	MAINTENANCE SUPERVISOR/HEAVY EQUIPMENT OPERATOR	



RELEVANT PROJECTS			
a.	<table border="1" style="width: 100%;"> <tr> <td style="width: 70%;">(1) TITLE AND LOCATION <b>Design Build San Jacinto Road Extension</b> Marine Corps Base, Camp Pendleton, CA</td> <td style="width: 30%;">(2) YEAR COMPLETED 2017-2018</td> </tr> </table>	(1) TITLE AND LOCATION <b>Design Build San Jacinto Road Extension</b> Marine Corps Base, Camp Pendleton, CA	(2) YEAR COMPLETED 2017-2018
	(1) TITLE AND LOCATION <b>Design Build San Jacinto Road Extension</b> Marine Corps Base, Camp Pendleton, CA	(2) YEAR COMPLETED 2017-2018	
<p>(3) BRIEF DESCRIPTION AND SPECIFIC ROLE      <input checked="" type="checkbox"/> Check if project performed with current firm</p> <p>Design Build San Jacinto Road Expansion at Marine Corps Base Camp Pendleton, CA. This <b>MILCON</b> project provided road and traffic circulation improvements to the entire installation and improved traffic flow and pedestrian safety.</p> <p>The project's work scope includes <b>included site clearing and grubbing, excavation/grading and shoring, roadway base materials, relocation of existing utilities such as power poles fire hydrants, storm drain inlets and structures, sewer mains and man holes, electrical conduits and pull boxes, traffic mitigation, sidewalks on both sides of the street, concrete curb &amp; gutters (both sides of the street), landscaping (temp and permanent), masonry fencing/walls for retaining, striping, signs and storm water drainage.</b></p> <p><b>Cost: \$4.3M Role: General Superintendent</b></p>			
b.	<table border="1" style="width: 100%;"> <tr> <td style="width: 70%;">(1) TITLE AND LOCATION <b>EDA Repave French Valley Airport</b> Murrieta, CA</td> <td style="width: 30%;">(2) YEAR COMPLETED 2017</td> </tr> </table>	(1) TITLE AND LOCATION <b>EDA Repave French Valley Airport</b> Murrieta, CA	(2) YEAR COMPLETED 2017
	(1) TITLE AND LOCATION <b>EDA Repave French Valley Airport</b> Murrieta, CA	(2) YEAR COMPLETED 2017	
<p>(3) BRIEF DESCRIPTION AND SPECIFIC ROLE      <input checked="" type="checkbox"/> Check if project performed with current firm</p> <p>This project was for the County of Riverside French Valley Airport, South Apron Pavement Reconstruction. The project consisted of demolition and removal of existing tie-down anchors. Demolition of the existing pavement by saw cutting and pulverization. Excavation of the subgrade involving, earthwork, spoiling, compaction, and grading, placement of aggregate base and fine grading. Installation of prefabricated trench drain and associated outlet piping. Installation of concrete valley gutter. Paving, coring and pavement marking. Construction of new tie-down anchors.</p> <p><b>Cost: \$1.6M Role: Superintendent</b></p>			
c.	<table border="1" style="width: 100%;"> <tr> <td style="width: 70%;">(1) TITLE AND LOCATION <b>City of Blythe Repave Broadway</b> Blythe, CA</td> <td style="width: 30%;">(2) YEAR COMPLETED 2017</td> </tr> </table>	(1) TITLE AND LOCATION <b>City of Blythe Repave Broadway</b> Blythe, CA	(2) YEAR COMPLETED 2017
	(1) TITLE AND LOCATION <b>City of Blythe Repave Broadway</b> Blythe, CA	(2) YEAR COMPLETED 2017	
<p>(3) BRIEF DESCRIPTION AND SPECIFIC ROLE      <input checked="" type="checkbox"/> Check if project performed with current firm</p> <p>The project consisted of the street improvements to Broadway Boulevard from 14th Avenue to Hobson Way and from Barnard Street to Station 8+83.73. The project included cold planning of existing pavement, the removal and disposal of various existing sections of curb and gutter, sidewalk, cross gutters, driveways and handicap curb returns. The grade adjustment of various utility appurtenances, the crack sealing of the roadway, the placement of a stress absorbing membrane interlayer (SAMI) over the roadway, the installation of new sections of curb and gutter, sidewalk, handicap ramps, spandrels, cross gutters and driveways. Also, the installation of a 2-inch-thick layer of new asphalt concrete over the entire roadway.</p> <p><b>Cost: \$1.1M Role: General Superintendent</b></p>			



	(1) TITLE AND LOCATION <b>Eagle Canyon Debris Basin/Dam</b> Cathedral City, CA	(2) YEAR COMPLETED 2015
	(3) BRIEF DESCRIPTION AND SPECIFIC ROLE <input checked="" type="checkbox"/> Check if project performed with current firm  This project constructed a new dam and debris basin, including mass earthwork (65,000 CY remediation export, 300,000 CY excavation), erosion control, blasting operations, and 2,300CY drainage structures. Oversight of in-house crews including: demolition, equipment operators, site utilities (storm drain), concrete, and excavation/grading. This project provided flood detention and hazard mitigation of rain, mud, and debris for Cathedral City.  <b>Cost: \$10.5M Role: General Superintendent</b>	
d.	(1) TITLE AND LOCATION <b>Design-Build Replace Fire Sprinklers at Buildings 6, 7, 8, 9, 10, 11, 12, 13, and 404</b> Defense Distribution Depot and Marine Corps Logistics Base Barstow, CA	(2) YEAR COMPLETED 2014
	(3) BRIEF DESCRIPTION AND SPECIFIC ROLE <input checked="" type="checkbox"/> Check if project performed with current firm  This <b>Design-Build</b> project was for the design and replacement of existing failed dry-pipe fire sprinkler systems in buildings 6, 7, 8, 9, 10, 11, 12, 13, and 404 at the Defense Distribution Depot and Marine Corps Logistics Base, Barstow, CA for NAVFAC SW. The scope of work included: excavation and trenching; <b>demolition and removal</b> of existing dry-pipe fire sprinkler systems; <b>new required piping</b> ; sprinkler heads; <b>alarm valve</b> ; <b>tamper and flow switches</b> ; double-check <b>assembly backflow preventers</b> (existing backflow preventers to remain); all <b>piping connections</b> to existing <b>water supply (existing underground laterals; backflow preventers</b> ; fire department connections; and backflow preventer test connections to remain where reused); and connections to existing fire alarm systems.  <b>Cost: \$9.1M                      Role: Quality Control Manager/Safety Program Management &amp; Oversight</b>	
e.	(1) TITLE AND LOCATION <b>Design-Build Repair Utility Meters</b> Beale Air Force Base, CA	(2) YEAR COMPLETED 2013
	(3) BRIEF DESCRIPTION AND SPECIFIC ROLE <input checked="" type="checkbox"/> Check if project performed with current firm  This <b>Design-Build</b> project was for the design and installation of utility meters at the Beale Air Force Base, CA for the U.S. Army Corps of Engineers. The scope of work included: repairing existing gas meters, electrical meters, and water meters; and installing new gas meters, electrical meters, and <b>water meters</b> for various buildings at Beale AFB. All meters were to be compatible with and connected to the Base's Direct Digital Control (DDC) Siemens Apogee System, INSIGHT Version 3.11 to allow remote monitoring.  <b>Cost: \$350K                      Role: Alternate Superintendent</b>	
f.	(1) TITLE AND LOCATION <b>Design-Build Repair Utility Meters</b> Beale Air Force Base, CA	(2) YEAR COMPLETED 2013
	(3) BRIEF DESCRIPTION AND SPECIFIC ROLE <input checked="" type="checkbox"/> Check if project performed with current firm  This <b>Design-Build</b> project was for the design and installation of utility meters at the Beale Air Force Base, CA for the U.S. Army Corps of Engineers. The scope of work included: repairing existing gas meters, electrical meters, and water meters; and installing new gas meters, electrical meters, and <b>water meters</b> for various buildings at Beale AFB. All meters were to be compatible with and connected to the Base's Direct Digital Control (DDC) Siemens Apogee System, INSIGHT Version 3.11 to allow remote monitoring.  <b>Cost: \$350K                      Role: Alternate Superintendent</b>	



	(1) TITLE AND LOCATION <b>Replace Water System Phase II</b> Vandenberg AFB, CA	(2) YEAR COMPLETED 2010-2011
	(3) BRIEF DESCRIPTION AND SPECIFIC ROLE <input checked="" type="checkbox"/> Check if project performed with current firm  <p>This project was for the replacement of a water system, Phase II, Vandenberg AFB, CA for the U.S. Army Corps of Engineers. The project mandated the provision of all labor, material and equipment necessary to <b>abandon and cap-off approximately 1,200 LF of existing 6"; 15,200 LF of 8"; 1,800 LF of 12"; 4,900 LF of 21" piping system; appurtenances in the main cantonment area</b> at Vandenberg Air Force Base; and replace the old system with new HDPE water pipe system. The scope of work included: <b>demolition; clearing and grubbing; excavation; backfill; compaction; saw-cutting existing asphalt roadways;</b> disposal of debris; <b>trench-line excavation;</b> concrete work; replacement of concrete curbs; gutters, sidewalks and <b>asphalt paving</b> to effect installation of the <b>new piping systems; pressure testing new system; flushing and sterilizing system; bacteriological testing;</b> and re-seeding and landscaping disturbed areas.</p> <p><b>Cost:</b> \$1.6M                      <b>Role:</b> Superintendent</p>	
g.	(1) TITLE AND LOCATION <b>Design-Build Install Photovoltaic Systems, Various Buildings, Marine Corps Air Ground Combat Center</b> Twenty-Nine Palms, CA	(2) YEAR COMPLETED 2010
	(3) BRIEF DESCRIPTION AND SPECIFIC ROLE <input checked="" type="checkbox"/> Check if project performed with current firm  <p>This <b>Design-Build</b> project was for the installation of Photovoltaic Systems in various buildings, Twenty-Nine Palms, CA for the U.S. Marine Corps. The scope of work consisted: of providing design; construction; permitting; commissioning; and training for a 200-KW DC rooftop solar photovoltaic (PV) system in buildings 1801, 1802, 1803, 1804, 1805, and 1210. The facility provides shelter for large military tanks. This system consisted of: photovoltaic module array mounted on support brackets for roofs; electrical terminal and combiner boxes; quick-connect electrical connectors; Direct Current (DC) wiring; DC disconnect; grid-connected inverter and isolation transformer; Alternating Current (AC) disconnect; and a web-based data acquisition and monitoring system (DAS).</p> <p><b>Cost:</b> \$2.2M                      <b>Role:</b> Quality Control Manager</p>	
h.	(1) TITLE AND LOCATION <b>Install Solar PV Power Systems, Bldgs. 1239 &amp; 1235</b> Yuma, AZ	(2) YEAR COMPLETED 2009
	(3) BRIEF DESCRIPTION AND SPECIFIC ROLE <input checked="" type="checkbox"/> Check if project performed with current firm  <p>This project provided complete engineering design; provision; installation; commissioning and testing for a grid-tied; and a 32kW Thin Film Technology Solar Photovoltaic (PV) system on the roof of structure Building 1239 and 1235.</p> <p>The project included seismically bracing the existing roof structure to support the entire solar array per local Yuma, AZ requirements in addition to waterproofing the brace and frame. The brace and framing required a minimum life of 25 years and was constructed as to not interfere with the existing function of the structure. In compliance with the BEAP, HHCI matched all brace and framing paint to the existing surfaces.</p> <p><b>Cost:</b> \$489K                      <b>Role:</b> Quality Control Manager</p>	
i.	(1) TITLE AND LOCATION <b>Install Solar PV Power Systems, Bldgs. 1239 &amp; 1235</b> Yuma, AZ	(2) YEAR COMPLETED 2009
	(3) BRIEF DESCRIPTION AND SPECIFIC ROLE <input checked="" type="checkbox"/> Check if project performed with current firm  <p>This project provided complete engineering design; provision; installation; commissioning and testing for a grid-tied; and a 32kW Thin Film Technology Solar Photovoltaic (PV) system on the roof of structure Building 1239 and 1235.</p> <p>The project included seismically bracing the existing roof structure to support the entire solar array per local Yuma, AZ requirements in addition to waterproofing the brace and frame. The brace and framing required a minimum life of 25 years and was constructed as to not interfere with the existing function of the structure. In compliance with the BEAP, HHCI matched all brace and framing paint to the existing surfaces.</p> <p><b>Cost:</b> \$489K                      <b>Role:</b> Quality Control Manager</p>	



	(1) TITLE AND LOCATION <b>Replace Asphalt with Concrete at Bike Lake Air Field</b> Ft. Irwin, CA	(2) YEAR COMPLETED 2009
	(3) BRIEF DESCRIPTION AND SPECIFIC ROLE <input checked="" type="checkbox"/> Check if project performed with current firm  This project was for the replacement of asphalt with concrete at Bike Lake Air Field, Ft. Irwin, CA for the U.S. Army Corps of Engineers. The scope of work included: <b>removing existing base material; pulverizing existing asphalt; compacting existing sub-grade;</b> reinstalling removed base material; installation of concrete with fiber mesh; the replacement of the existing asphalt taxiway area with <b>concrete taxiway</b> ; the construction of a barrier wall between the lake and taxiway; installation of joint sealant in the control joints; and installation of <b>striping</b> of the replaced taxiway area.  <b>Cost:</b> \$1.9M <b>Role:</b> Alt. Quality Control Manager/Site Safety & Health Officer	
j.	(1) TITLE AND LOCATION <b>U.S. Army Reserve Tactically Training Base</b> <b>60 Solar Security Lights</b> Fort Hunter Liggett, CA	(2) YEAR COMPLETED 2008
	(3) BRIEF DESCRIPTION AND SPECIFIC ROLE <input checked="" type="checkbox"/> Check if project performed with current firm  This project required provision of all parts, materials, labor, and equipment to assemble and install 60 solar security lights around the perimeter of the base cantonment area and the access points of Fort Hunter Liggett, CA for the U.S. Army Corps of Engineers. The scope of work included: Solar light kits consisting of a Model SOL TPM 250 SIN 203-98 UL listed Self-contained Solar Power Unit with three gel cell sealed batteries, controller, cobrahead fixture, LED lamp, 42 watts, 6500 Kelvin rating, mounting brackets, and 30' Direct Burial Bronze fiberglass pole. Units are specified to match newly installed Security Light System.  <b>Cost:</b> \$538K <b>Role:</b> Project Manager/Site Safety & Health Officer/QC Manager	
k.	(1) TITLE AND LOCATION <b>Design-Build Recreational Vehicle Storage Lot</b> Marine Corps Air Station Miramar, CA	(2) YEAR COMPLETED 2008
	(3) BRIEF DESCRIPTION AND SPECIFIC ROLE <input checked="" type="checkbox"/> Check if project performed with current firm  This <b>Design-Build</b> project was for the design and construction of an 807stall vehicle storage lot at Marine Corps Air Station Miramar, CA for NAVFAC SW. The scope of work included: <b>demolition;</b> material removal; soil stabilization; treatment of lime and ash; <b>clearing and grubbing; rough grading;</b> drainage swales; storm basin; concrete placement; the construction of a 3" thick layer compacted decomposed granite over an 18" thick layer of lime and fly ash treated soil; 2" wide white <b>traffic paint markings; paved asphalt access road</b> with curb and gutter; new energy efficient solar security lighting; 30-foot wide access gates with mechanized operator; key pad access system; 15' wide by 250' long staging/parking area and 130' diameter turn around area; 24' wide manual gate for emergency vehicle use; <b>fire suppression system</b> (including two <b>above ground 30,000 gallon water tanks</b> with 4 1/2 inch Siamese fire department hose connections); automatic fill and level control <b>valve assembly</b> (to monitor per NFPA 22 and 72 requirements) with signals sent over two telephones via DACT to a receiving station; security chain link/barb wire fencing; and an <b>RV dump site with an underground 10,000 gallon wastewater holding tank with integral wash down facilities.</b> This area is used by the following military operation vehicles: fire truck; pump trucks; and recreational vehicles.  <b>Cost:</b> \$3.5M <b>Role:</b> Superintendent/Site Safety & Health Officer	
i.	(1) TITLE AND LOCATION <b>Design-Build Recreational Vehicle Storage Lot</b> Marine Corps Air Station Miramar, CA	(2) YEAR COMPLETED 2008
	(3) BRIEF DESCRIPTION AND SPECIFIC ROLE <input checked="" type="checkbox"/> Check if project performed with current firm  This <b>Design-Build</b> project was for the design and construction of an 807stall vehicle storage lot at Marine Corps Air Station Miramar, CA for NAVFAC SW. The scope of work included: <b>demolition;</b> material removal; soil stabilization; treatment of lime and ash; <b>clearing and grubbing; rough grading;</b> drainage swales; storm basin; concrete placement; the construction of a 3" thick layer compacted decomposed granite over an 18" thick layer of lime and fly ash treated soil; 2" wide white <b>traffic paint markings; paved asphalt access road</b> with curb and gutter; new energy efficient solar security lighting; 30-foot wide access gates with mechanized operator; key pad access system; 15' wide by 250' long staging/parking area and 130' diameter turn around area; 24' wide manual gate for emergency vehicle use; <b>fire suppression system</b> (including two <b>above ground 30,000 gallon water tanks</b> with 4 1/2 inch Siamese fire department hose connections); automatic fill and level control <b>valve assembly</b> (to monitor per NFPA 22 and 72 requirements) with signals sent over two telephones via DACT to a receiving station; security chain link/barb wire fencing; and an <b>RV dump site with an underground 10,000 gallon wastewater holding tank with integral wash down facilities.</b> This area is used by the following military operation vehicles: fire truck; pump trucks; and recreational vehicles.  <b>Cost:</b> \$3.5M <b>Role:</b> Superintendent/Site Safety & Health Officer	



	(1) TITLE AND LOCATION	(2) YEAR COMPLETED
	<b>Remove and Replace Hardstand around Bldg. 573 at the Yermo Annex</b> Marine Corps Logistics Base, Barstow, CA	2007
m.	(3) BRIEF DESCRIPTION AND SPECIFIC ROLE <input checked="" type="checkbox"/> Check if project performed with current firm  This phased project (phases 1-3) was for the removal and replacement of hardstand around building 573 at Yermo Annex, Marine Corps Logistics Base, Barstow, CA for NAVFAC SW. The scope of work included: <b>removing and replacing</b> designated areas of the <b>hardstand</b> ; cutting and removing existing concrete; prepping and re-installing approximately 122,000 SF of a higher grade, 8 to 12 inches thick <b>concrete pavement</b> ; and repairing the lifting and cracking pavement at the nearby motorcycle parking lot.  <b>Cost:</b> \$3.3M <b>Role:</b> Superintendent	
	(1) TITLE AND LOCATION ( <i>City and State</i> )	(2) YEAR COMPLETED
	<b>Design-Build NEX Complex Roads &amp; Parking Reconfiguration</b> Naval Base Coronado, CA	2005
n.	(3) BRIEF DESCRIPTION ( <i>Brief scope, size, cost, etc.</i> ) AND SPECIFIC ROLE <input checked="" type="checkbox"/> Check if project performed with current firm  This <b>Design-Build</b> project was for the reconfiguration of NEX Complex roads and parking lot, Naval Base Coronado, CA for NAVFAC SW. The scope of work included: the Design-Build of the Naval Exchange and Commissary Complex Parking Lots and street flow patterns; <b>asphalt pavement</b> demolition; placement of 1,700 LF of curb; 1,120 tons base and 650 tons of new asphalt pavement; sidewalks; an 880 LF curb and gutter; landscaping islands (including trees; plants; and irrigation system); relocation of existing light poles; relocation of a drive-through call box; installation of island irrigation system; and new driveway access from the street. The project required coordination of work around <b>heavy traffic</b> and visitors in occupied and operational military base, and provision of crew housing.  <b>Cost:</b> \$473K <b>Role:</b> Superintendent	
	(1) TITLE AND LOCATION	(2) YEAR COMPLETED
	<b>Main Access Control Point Modernization</b> Fort. Irwin, CA	2005
o.	(3) BRIEF DESCRIPTION AND SPECIFIC ROLE <input checked="" type="checkbox"/> Check if project performed with current firm  This project for the upgrading of the Main Access Control Point Modernization, Ft. Irwin, CA for the U.S. Army Corps of Engineers. The scope of work included: Fort Irwin's Main Access Control Point facility to meet new Department of Defense anti-terrorism force protection regulations; requiring extensive modernization and site improvements. HHCI successfully executed this project while facing difficult project remote locale; work in extreme temperatures; management of deliveries to remote site; coordinating work in multiple sites concurrently; and coordinating work around <b>heavy traffic</b> and installation's operational ingress and egress areas. Construction operations included: construction of guard stations; installation of blast resistant metals; doors; frames; windows; heating and cooling system installation; restroom facilities; <b>plumbing</b> ; addition of architectural stone to building facade; and construction of 50x60 FT canopy system. Government additional requests for work included: location of power to visitor's center; <b>additional asphalt paving</b> ; new concrete pad; and power pole relocation.  <b>Cost:</b> \$2.7M <b>Role:</b> Alternate Superintendent/Operator	



	(1) TITLE AND LOCATION <b>Lytle Creek Stockton Flats Road Widening &amp; Reconstruction</b> San Bernardino, CA	(2) YEAR COMPLETED 2004
	(3) BRIEF DESCRIPTION AND SPECIFIC ROLE <input checked="" type="checkbox"/> Check if project performed with current firm This project was for the widening and reconstruction of Stockton Flats Road, Lytle Creek, CA for U.S. Forestry Service. The scope of work included: <b>pulverizing existing pavement; grading of sub-base and base course; placement of base course</b> ; construction of drainage structures and restoration of disturbed areas. The project was approximately 4 miles long with 1 mile of existing pavement. The remaining 3 miles was an existing dirt road that required widening with some major cut/fill areas. Project work areas included: <b>clearing and grubbing</b> ; structure/obstruction removal; <b>excavation</b> ; embankment and haul; soil erosion and pollution control; <b>pulverizing existing pavement; grading of sub-base and base course</b> ; placement of 2,720 tons crushed aggregate and compaction; reconditioning of roadbed; placement of 4,760 tons <b>A/C pavement</b> ; 24” and 73” concrete headwall; <b>24” corrugated metal pipe</b> ; corrugated metal pipe arch; 4,646 LF bituminous concrete curb; corrugated metal spillways; rock drainage field; placement of little mac spillways; concrete low water crossing; striping; placed and mortared rip-rap; emergency repair from flood damage (rebuilding road prism and 6’ berm on shoulder); removal of gate and old asphalt; construction of inlet apron; traffic signage with bullet proof sign backing; and asphalt repair (saw cut edges, <b>backfill, compact backfill, pave edges and damaged asphalt areas</b> ).  <b>Cost:</b> \$479K <b>Role:</b> Alternate Superintendent/Operator	
p.	(1) TITLE AND LOCATION <b>Bear Valley Paving</b> Various Cities, CA	(2) YEAR COMPLETED 2001-2003
	(3) BRIEF DESCRIPTION AND SPECIFIC ROLE <input type="checkbox"/> Check if project performed with current firm This project for the paving of Bear Valley for various cities in California. The scope of work included: <b>paving; grading; pipeline installations</b> ; roadway clearance; roadway construction; and other <b>heavy civil related activities</b> .  <b>Cost:</b> \$20K-\$2M <b>Role:</b> Superintendent/Heavy Equipment Operator	
q.	(1) TITLE AND LOCATION <b>A.J. Acosta Company</b> Various Cities, CA	(2) YEAR COMPLETED 1998-2001
	(3) BRIEF DESCRIPTION AND SPECIFIC ROLE <input type="checkbox"/> Check if project performed with current firm This project was for A.J. Acosta Company in various cities throughout California. The scope of work included: various <b>land clearing; demolition; access and roadway construction; grading</b> ; and other <b>civil related activities</b> .  <b>Cost:</b> \$20K-\$1M <b>Role:</b> Superintendent/Operator	
r.		



NAME														
<b>Thomas James “TJ” Lancaster</b>	<b>Corporate Safety Manager</b>	<b>20+</b>												
<b>FIRM NAME AND LOCATION</b> Hal Hays Construction, Inc., Riverside, CA		<b>YEARS EXPERIENCE</b> a. TOTAL <b>20+</b> b. WITH CURRENT FIRM Less than 1yr												
<b>EDUCATION</b> <ul style="list-style-type: none"> <li>▪ Health &amp; Safety Management Certificate</li> <li>▪ Electrical Safety Certificate</li> <li>▪ 7505 Accident Investigation Certificate</li> <li>▪ 2264 Permit Confined Space Certificate</li> <li>▪ 5119 CALOSHA General Industry Certificate</li> <li>▪ 521 Industrial Hygiene Certificate</li> <li>▪ 40-Hazwoper First Responder</li> <li>▪ OSHA DOT Security &amp; Transport Certificate</li> <li>▪ 511 General Industry Safety Certificate</li> <li>▪ Silica in the work place Trainer</li> <li>▪ Blood Borne Pathogens Certificate</li> <li>▪ 2017 EM 385-1-1 40-Hour</li> <li>▪ OSHA 501 Trainer</li> <li>▪ OSHA 500 Trainer</li> <li>▪ OSHA 10-Hour Certificate</li> <li>▪ CPR and First Aid Instructor</li> <li>▪ 995 Confined Space Trainer</li> <li>▪ Excavation and Trenching Training</li> <li>▪ Fall Protection Training</li> <li>▪ Scaffolding Training</li> <li>▪ Powder Actuated Tools Training</li> <li>▪ Workplace Harassment Training</li> <li>▪ 510 OS&amp;H for Construction Industry Certificate</li> </ul>														
<b>OTHER PROFESSIONAL QUALIFICATIONS</b> <p>Mr. Lancaster has extensive experience in Department of Defense, Government, Public and Private work sector with <b>facility renovation, new construction of buildings</b>, and heavy/civil construction. He maintains specific experience in this project’s work areas such as: <b>facility construction and renovation; facility maintenance, upgrades and repairs; electrical, HVAC, fire alarm and fire sprinkler systems, doors &amp; locks, lighting upgrade, demolition, site work, utilities, PEBS</b>, and project site safety.</p> <p><b>Software Skills:</b> MS Windows Professional, MS Office Suite, MS Outlook, Primavera CPM Scheduling, SAGE Masterbuilder</p> <p><b>Job Skills:</b> Safety Management, Safety Regulations, Scheduling, Safety Tasks, Supervision, Training, Quality Control, Crew Production, Scheduling and Coordinating Subcontractors, Heavy Civil Operations, and Project Management</p> <p>For the following projects, Mr. Lancaster executed the role of Corporate Site Safety Health Officer including: coordinating meetings and negotiations; recommendation of design and project changes to provide the client the best value for their project; provision of technical oversight for construction start up and testing; maintaining day to day project scheduling; executing the construction schedule (CPM); supervising work force and subcontractors; implementing safety programs and procedures; preparation of AHAs; site inspections; advising management of any deficiencies; safety training; accident investigation and reporting; safety inspection to ensure compliance; and maintaining Quality Control information on a daily basis. Additional responsibilities include conducting and supervising on-site management staff, assisting in technical submittal reviews, and on-site inspections.</p>														
<b>EMPLOYMENT HISTORY</b> <table style="width: 100%; border-collapse: collapse;"> <tr> <td style="width: 15%;">2018 - Present</td> <td style="width: 45%;">Hal Hays Construction, Inc., Riverside, CA</td> <td style="width: 40%;">Corporate Safety Manager</td> </tr> <tr> <td>2016 - 2018</td> <td>Mark Beamish Waterproofing, Irvine, CA</td> <td>Health &amp; Safety Manager</td> </tr> <tr> <td>2014 - 2016</td> <td>Roy Jorgensen Associates, Irvine, CA</td> <td>Health &amp; Safety Manager</td> </tr> <tr> <td>2009 - 20013</td> <td>Southern California Edison, CA</td> <td>EH&amp;S Radiological Waste Tech</td> </tr> </table>			2018 - Present	Hal Hays Construction, Inc., Riverside, CA	Corporate Safety Manager	2016 - 2018	Mark Beamish Waterproofing, Irvine, CA	Health & Safety Manager	2014 - 2016	Roy Jorgensen Associates, Irvine, CA	Health & Safety Manager	2009 - 20013	Southern California Edison, CA	EH&S Radiological Waste Tech
2018 - Present	Hal Hays Construction, Inc., Riverside, CA	Corporate Safety Manager												
2016 - 2018	Mark Beamish Waterproofing, Irvine, CA	Health & Safety Manager												
2014 - 2016	Roy Jorgensen Associates, Irvine, CA	Health & Safety Manager												
2009 - 20013	Southern California Edison, CA	EH&S Radiological Waste Tech												



**RELEVANT PROJECTS**

RELEVANT PROJECTS	
<p>(1) TITLE AND LOCATION</p> <p><b>Design-Build Expand Biola University, Lydia Lim Center for Science, Technology and Health</b> La Mirada, CA</p>	<p>( ) YEAR COMPLETED</p> <p style="text-align: center;">2018</p>
<p>a.</p>	<p>(3) BRIEF DESCRIPTION AND SPECIFIC ROLE      <input type="checkbox"/> Check if project performed with current firm</p> <p><u>Project Description:</u></p> <p>This design-build project was for design and construction of renovations and expansions to Biola University 13800 Biola Ave La Mirada, Ca. 90639. The project was to add the Science, Technology and Health Center. This addition increased Biolas building capacity by 91,200 sq. ft. adding 27 laboratories, six classrooms, a human anatomy suite, green house space for the botany program, a dedicated SEM (scanning and electron microscope) lab and TEM (transmission electron microscope) lab, and state-of-the art technology.</p> <p>The scope of work included: resilient flooring; concrete polishing; above and below grade waterproofing.</p> <p>Design Build Effort: In addition, design build work included design for clean air purifying systems for the floor grinding process to minimize any hazardous silica release. Mark Beamish Waterproofing worked around occupied and operational facilities including the phasing and sequencing of work progress to minimize any potential exposure to hazardous substances.</p> <p>Awards and Recognition:</p> <p>This project was completed with no safety accident or incidents (360 days) and received a CalOSHA's Golden Award.</p> <p><u>Job Duties:</u></p> <p>Duties included the management of the health and safety program for the jobsite and in the event of unsafe or life-threatening work practices by any personnel on the referenced project to stop work. Other duties included the removal of any individual from the project who consistently failed to perform their work in compliance with the project regulations, to inspect all equipment as it is delivered to the jobsites and verify compliance with site safe regulations, to update Activity Hazard Analysis as needed, to hold weekly safety meetings, to attend jobsite meetings as needed, and to give new employees orientations training.</p> <p><b>Cost: \$63 million      Role: Health &amp; Safety Manager</b></p>
<p>b.</p>	<p>(1) TITLE AND LOCATION</p> <p><b>Build OCPC/Broadcom Campus</b> Irvine, CA</p>
<p>(3) BRIEF DESCRIPTION AND SPECIFIC ROLE      <input type="checkbox"/> Check if project performed with current firm</p> <p><u>Project Description:</u></p> <p>This design-build project was for design and construction of Broadcom Great Parks Campus 1 Civic Center Plaza Irvine, Ca. This project consists of two 5-story buildings of offices, 30 R &amp; D labs, training facilities, loading docks, kitchen and cafeteria and a fitness center for employees. Also included in the project are two 4-story buildings totaling 380,000 sf of core and shell space and 73 acres.</p> <p>The scope of work included:</p> <p>Site grading; site utilities; concrete work; landscaping; SWPPP and BMP implementation; structural steel; stucco; single ply membrane and standing seam roofing; AT/FP compliant energy efficient windows/doors; mechanical systems; electrical distribution systems; plumbing systems; fire suppression, alarm, and life safety systems; operable partition wall;</p>	<p>( ) YEAR COMPLETED</p> <p style="text-align: center;">2018</p>



	<p>drywall and insulation; acoustical and drywall ceilings; cabinetry; resilient flooring; ceramic tile; concrete polishing; above and below grade waterproofing; painting; restroom accessories; podium deck hot rubber waterproofing.</p> <p><u>Job Duties:</u></p> <p>Duties included the management of the health and safety program for the jobsite and in the event of unsafe or life-threatening work practices by any personnel on the referenced project to stop work. Other duties included the removal of any individual from the project who consistently failed to perform their work in compliance with the project regulations, to inspect all equipment as it is delivered to the jobsites and verify compliance with site safe regulations, to update Activity Hazard Analysis as needed, to hold weekly safety meetings, to attend jobsite meetings as needed, and to give new employees orientations &amp; training.</p> <p><b>Cost: \$778M    Role: Health &amp; Safety Manager</b></p>	
c.	<p>(1) TITLE AND LOCATION</p> <p><b>Toyota North American Headquarters</b> Plano, TX</p>	<p>( ) YEAR COMPLETED</p> <p>2017</p>
	<p>(3) BRIEF DESCRIPTION AND SPECIFIC ROLE    <input type="checkbox"/> Check if project performed with current firm</p> <p><u>Project Description:</u></p> <p>This design-build project was for design and construction of Toyota North American Headquarters. The project was sits on 100 acres.; 7,000+ parking spaces; 7 BUILDINGS.</p> <p>The scope of work included:</p> <p>Site grading; site utilities; concrete work; landscaping; SWPPP and BMP implementation; structural steel; stucco; AT/FP compliant energy efficient windows/doors; mechanical systems; electrical distribution systems; plumbing systems; fire suppression, alarm, and life safety systems; operable partition wall; drywall and insulation; acoustical and drywall ceilings; cabinetry; resilient flooring; ceramic tile; concrete polishing; above and below grade waterproofing; painting; restroom accessories; podium deck hot rubber waterproofing, Largest onsite solar installation; state-of-the art rainwater capturing system; exterior landscaping drought resistant; 8.79-megawatts array of more than 20,00 solar panels; a rainwater harvesting system that holds up 400,00 gallons.</p> <p>Awards and Recognition:</p> <p>Toyota was awarded the LEED Platinum award for sustainable ENERGY.</p> <p><u>Job Duties:</u></p> <p>Duties included the management of the health and safety program for the jobsite and in the event of unsafe or life-threatening work practices by any personnel on the referenced project to stop work. Other duties included the removal of any individual from the project who consistently failed to perform their work in compliance with the project regulations, to inspect all equipment as it is delivered to the jobsites and verify it is in compliance with site safe regulations, to update Activity Hazard Analysis as needed, to hold weekly safety meetings, to attend jobsite meetings as needed, and to give new employees orientations &amp; training.</p> <p><b>Cost: \$23.4 Billion    Role: Health &amp; Safety Manager</b></p>	
d.		<p>( ) YEAR COMPLETED</p>



<p>(1) TITLE AND LOCATION</p> <p><b>Southern California Edison Nuclear Security</b> San Onofre, CA</p>	<p>2009-2013</p>
<p>(3) BRIEF DESCRIPTION AND SPECIFIC ROLE <input type="checkbox"/> Check if project performed with current firm</p> <ul style="list-style-type: none"> <li>• Certified 40-hour Hazwoper and first responder</li> <li>• Certified DOT Hazardous Material Transport and security</li> <li>• Maintained OSHA 300 and 300A Log.</li> <li>• Performed All Hazardous Material and Safety training for the EH&amp;S Team</li> <li>• Provided coordination of all hazardous &amp; radiological waste and material packaging and shipments.</li> <li>• Managed contract labor contract for all safety, hazardous &amp; radiological waste and material activities.</li> <li>• Knowledge of Safety regulations and permits to ensure program compliance.</li> <li>• Coordinates inspections with outside agencies.</li> <li>• Provided technical recommendations related to general technical knowledge, which relate to specific projects and tasks.</li> <li>• Created and maintains records, logs, documents, files, or databases for use in monitoring, tracking of Hazardous &amp; radiological Waste shipping manifest.</li> <li>• Knowledge in generating hazardous &amp; radiological waste manifests</li> <li>• Experience with the DOT Safety, California Environmental Reporting System (CERS) and Federal/State (BRSW4) annual/biennial report software.</li> <li>• Experience performing hazardous &amp; radiological waste staging areas.</li> <li>• Knowledge of General Industry and Construction Safety.</li> <li>• Knowledge Safety Regulations and bio hazardous &amp; radiological program and regulations</li> <li>• Knowledge of industry policies, procedures, codes, objectives, strategies, goals, demonstrated experience interfacing and collaborating with internal and external stakeholders (e.g., clients, corporate officers, bargaining unit personnel, management, vendors) to meet business needs.</li> <li>• Performed Construction Safety, Environmental/Hazmat Inspections and Testing.</li> <li>• Performing Safety walk downs of all tactical drill and/or training in accordance with Nuclear Regulatory Commission requirements.</li> <li>• Performed continuous Safety and Quality Assurance checks affecting surveillance of Protected Area barrier intrusion detection segments and periodic checks and surveillances of the Protected Area gates and Vital Area portals and gates on foot patrol.</li> <li>• Performed Safety training for all positive access control functions at Owner Controlled Access entry points to prevent introduction of prohibited items and to ensure the protection of special nuclear material and to guard against radiological sabotage.</li> <li>• Processing and issuing notifications for drug/alcohol testing as required.</li> <li>• Performed (ERO) Emergency Response Duties and nuclear Emergency Response Personnel duties at emergency response facilities and plant evacuation gates.</li> <li>• Maintaining a safety conscious work environment by following safety protocols and safe work practices.</li> <li>• Performed Safety and Hazmat First Responder Duties for Security safety Team #5</li> </ul> <p><b>Role: Nuclear Security &amp; Hazardous Material Safety Officer 1</b></p>	



NAME								
NAME	ROLE IN THIS CONTRACT	YEARS EXPERIENCE						
<b>Jason Flowers</b>	<b>Quality Control Manager</b>	<table border="1" style="width: 100%; border-collapse: collapse;"> <tr> <td style="width: 50%; text-align: center;">a. TOTAL <b>13</b></td> <td style="width: 50%; text-align: center;">b. WITH CURRENT FIRM <b>3</b></td> </tr> </table>	a. TOTAL <b>13</b>	b. WITH CURRENT FIRM <b>3</b>				
a. TOTAL <b>13</b>	b. WITH CURRENT FIRM <b>3</b>							
<b>FIRM NAME AND LOCATION</b> Hal Hays Construction Inc., Riverside, CA								
<b>EDUCATION</b> <ul style="list-style-type: none"> <li>▪ 2007 Bachelor of Science, Physiology</li> <li>▪ University of California, Santa Barbara</li> <li>▪ Water Distribution Operator Level 1</li> <li>▪ Water Treatment Operator Level 1</li> <li>▪ 2015 NAVFAC Construction Quality Management for Contractors</li> <li>▪ OSHA 10 Certificate (in training)</li> </ul>								
<b>OTHER PROFESSIONAL QUALIFICATIONS</b> Mr. Flowers has extensive Edison, Department of Defense, PUC, public and private sector experience related to Design-Build, substations, building construction, underground utilities, and heavy civil construction. He maintains specific experience in this project's work areas such as: energized sites, trenching, earthwork, major utilities, concrete structures, paving, structural concrete, facility construction, renovations and work on active and operational sites.  <b>Software Skills:</b> MS Windows Professional, MS Office Suite, MS Outlook, Primavera CPM Scheduling, and Sage MasterBuilder  <b>Job Skills:</b> Project Management, Quality Control, Scheduling, Project Coordination and Safety Tasks  For the following projects, Mr. Flowers has executed the role of QCM/PM, including: Responsibilities included: coordinating meetings and negotiations; recommendation of design and project changes to provide the client the best value for their project; provision of technical oversight for construction start up, and maintaining Quality Control information on a daily basis, including the Contractor Quality Control (CQC) Plan elements, such as: quality control organization, definable features of work, submittal register, QC requirements, equipment list, Daily CQC Report, QC punch list items, QC testing, transferred and installed property, and user training requirements. Additional responsibilities include conducting and supervising on-site management staff, assisting in technical submittal reviews, and on-site inspections.								
<b>EMPLOYMENT HISTORY</b> <table style="width: 100%; border-collapse: collapse;"> <tr> <td style="width: 15%;">2015 - Present</td> <td style="width: 45%;">Hal Hays Construction, Inc., Riverside, CA</td> <td style="width: 40%;">QC Manager, Project Manager</td> </tr> <tr> <td>2005 - 2015</td> <td>San Bernardino County Department of Environmental Health</td> <td>Superintendent/Environmental Health Inspector</td> </tr> </table>			2015 - Present	Hal Hays Construction, Inc., Riverside, CA	QC Manager, Project Manager	2005 - 2015	San Bernardino County Department of Environmental Health	Superintendent/Environmental Health Inspector
2015 - Present	Hal Hays Construction, Inc., Riverside, CA	QC Manager, Project Manager						
2005 - 2015	San Bernardino County Department of Environmental Health	Superintendent/Environmental Health Inspector						

RELEVANT PROJECTS		
a.	(1) TITLE AND LOCATION <b>SGVW Plant W1 Replace Chlorination Building</b> Whittier, CA	() YEAR COMPLETED  2018
	(3) BRIEF DESCRIPTION AND SPECIFIC ROLE <input checked="" type="checkbox"/> Check if project performed with current firm  <u><b>Project Description:</b></u> This project involved the removal of the existing steel chlorination building, existing <b>electrical conduits</b> and <b>light fixtures; design</b> and construction of new <b>steel replacement building</b> ; installation of new <b>light fixtures</b> , fresh <b>air supply fan</b> , a <b>roll-up access door</b> , and a 90 minute <b>fire door</b> ; reconnecting the existing <b>chlorine equipment</b> , <b>electrical system</b> , and <b>plumbing</b> and related work at the Plant W1 Chlorination Building, located in Whittier, CA.  <b>Cost:</b> \$130K <span style="margin-left: 150px;"><b>Role:</b> QCM/Project Manager</span>	
b.	(1) TITLE AND LOCATION <b>Fontana Water Co. Afterbay Improvements at Plant F11</b> Rialto, CA	() YEAR COMPLETED  2017
	(3) BRIEF DESCRIPTION AND SPECIFIC ROLE <input checked="" type="checkbox"/> Check if project performed with current firm  <u><b>Project Description:</b></u> This project involved removing <b>30-inch piping</b> , removing interior <b>concrete walls</b> , removing wooden slats, removing and reinstalling of <b>steel guide plates</b> , saw cutting grooves, repairing and recoating submerged concrete surface, blasting and recoating steel surfaces, caulking around items to be protected, installing blind flanges, a trash rack, sluice gates, cutting pipe and installing a valve work at the afterbay, located in Rialto, CA.  <b>Cost:</b> \$301K <span style="margin-left: 150px;"><b>Role:</b> QCM/Project Manager</span>	
c.	(1) TITLE AND LOCATION <b>SGVW Construction of Site Improvements at Plant No. 11 Ph2</b> El Monte, CA	() YEAR COMPLETED  2017
	(3) BRIEF DESCRIPTION AND SPECIFIC ROLE <input checked="" type="checkbox"/> Check if project performed with current firm  <u><b>Project Description:</b></u> Construction of a <b>concrete sidewalk</b> , a <b>street light</b> , a <b>6-inch mow curb</b> ; installation of 1-inch <b>crushed rock</b> , <b>perimeter landscaping</b> , <b>irrigation system</b> , <b>concrete swales</b> , <b>grading</b> , <b>installation of Class II base</b> , <b>relocation of PVC pipe</b> , construction of <b>storage bays</b> for dirt stockpiles and construction of <b>split face block wall</b> at the Plant No. 11 located at 12638 Pineview Street in the City of El Monte, California  <b>Cost:</b> \$628K <span style="margin-left: 150px;"><b>Role:</b> Project Manager/QCM</span>	
e.	(1) TITLE AND LOCATION <b>SGVW Reservoir Demolition at Plant F37</b> Fontana, CA	() YEAR COMPLETED  2017





<p>(1) TITLE AND LOCATION</p> <p><b>Eastern Municipal Water District Public Access Areas Renovation</b> Perris, CA</p>	<p>2012-2016</p>
<p>(3) BRIEF DESCRIPTION AND SPECIFIC ROLE <input checked="" type="checkbox"/> Check if project performed with current firm</p> <p><b><u>Project Description:</u></b></p> <p>This project was comprised of construction in four specific public access areas of the District’s Administration Center and Operations and Maintenance Center building complex and appurtenant site work. The building renovation work included, but was not limited to, new restrooms, <b>plumbing fixtures</b>, interior finishes, exterior finishes, casework, HVAC modifications, electrical conduit, wiring, lighting, concrete site work, aluminum storefront and glazing, bullet-proof glazing and walls, <b>wet utilities</b>, and associated appurtenances. Also, the project included construction phasing, which required the completion of one public access area and client hand off prior to the beginning of subsequent work areas. Additionally, each phase was completed under contractual work durations and client directed sequencing dictated by Milestone Completion Dates.</p> <p><b>Awards and Recognition:</b> This project was completed with no safety accidents or near misses.</p> <p><b>Cost:</b> \$1.9M     <b>Role:</b> Project Manager</p>	
<p>(1) TITLE AND LOCATION</p> <p><b>Design-Build: Repair Potable Water Valves</b> Marine Corp Recruit Depot, San Diego, CA</p>	<p>( ) YEAR COMPLETED</p> <p>2016</p>
<p>(3) BRIEF DESCRIPTION AND SPECIFIC ROLE <input checked="" type="checkbox"/> Check if project performed with current firm</p> <p><b><u>Project Description:</u></b></p> <p>J This project was to remove and replace deteriorated and non-functioning Potable Water Distribution Valves throughout the Marine Corps Recruit Depot (MCRD) in San Diego. Existing valves and pipes were demolished and replaced with like kind valves and pipes at various locations as indicated in the contract documents. A total of 270 valves were replaced, varying in size from 4” to 10”. Additionally, five (5) feet of length pipe on each side of each valve were required to be replaced, totaling 2,700 LF. The project also includes the installation of all necessary coupling, valve boxes, thrust blocks, and replacing concrete, asphalt, and landscape to restore each site to the original condition. Approximately 40% of the valves were on asphalt pavement, 40% on concrete flat work, and 20% were on landscaped areas.</p> <p><b>Cost:</b> \$2.62M     <b>Role:</b> Project Engineer</p>	
<p>(1) TITLE AND LOCATION</p> <p><b>Design-Build Potable Water Storage Tank 25191</b> Marine Corps Base, Camp Pendleton, CA</p>	<p>( ) YEAR COMPLETED</p> <p>2016</p>
<p>(3) BRIEF DESCRIPTION AND SPECIFIC ROLE <input checked="" type="checkbox"/> Check if project performed with current firm</p> <p><b><u>Project Description:</u></b></p> <p>k. This project wa to remove and replace deteriorated clear water reservoir a the Marine Corps Base at Camp Pendleton, San Diego, CA. Existing tank and water distribution lines were demolished and replaced. During this period of</p>	

	<p>demolition and re-construction of the permanent facilities, a temporary water storage and distribution system was built in place and operated to serve the functions of the previous system.</p> <p><b>Cost:</b> \$1.05M    <b>Role:</b> Project Engineer</p>	
	(1) TITLE AND LOCATION	( ) YEAR COMPLETED
	<p><b>Design-Build Repair Re-Circulation Lines B-619</b> Marine Corps Recruit Depot, San Diego, CA</p>	2015-2016
l.	(3) BRIEF DESCRIPTION AND SPECIFIC ROLE <input checked="" type="checkbox"/> Check if project performed with current firm	
	<p><b>Project Description:</b> This Design-build project includes replacement of Domestic Hot Water branch laterals from Main to Recirculation Loop. The project will demolish all existing DHW copper plumbing lines, fittings and valves within the DHW supply system. The project will install new domestic hot water Type K copper plumbing lines, valves and fittings along with new isolation valves. The project will dispose of all demolished material in a legal manner consistent with state and local laws. Areas affected by repair/construction will be in compliance with applicable ATFP, Fire Suppression, Seismic, Accessibility, ASHRAE, and LEEDs codes and standards (as required) upon completion of the project. Paint, tag and label with flow direction the equipment and pipes. Insulate hot water pipes according to ASHRAE requirements.</p> <p><b>Cost:</b> \$1.19M    <b>Role:</b> Project Manager</p>	
	(1) TITLE AND LOCATION	( ) YEAR COMPLETED
	<p><b>Design-Build Repair Vault Drain and Overflow at Reservoir 20813</b> Marine Corps Base, Camp Pendleton, CA</p>	2016
m.	(3) BRIEF DESCRIPTION AND SPECIFIC ROLE <input checked="" type="checkbox"/> Check if project performed with current firm	
	<p><b>Project Description:</b> This Design-Build project consists of removing and replacing fill/feed pipe, installing new 20813 valve vaults, and installing new drain lines. The work shall include removing and abandoning fill/feed pipe and re-routing all new HDPE pipe with high point vents and isolation valves, removing and replacing valve vault with reinforced concrete slabs and self-draining appurtenances, providing overflow and drain lines with flexible duckbill check valve at end, disconnecting emergency feed pipe and reconnecting to new HDPE feed pipe, and flushing, disinfecting, and performing bacterial tests required for new piping and appurtenances.</p> <p><b>Cost:</b> \$1.6M    <b>Role:</b> Project Engineer</p>	
	(1) TITLE AND LOCATION	( ) YEAR COMPLETED
	<p><b>Environmental Health Inspection</b> San Bernardino County, CA</p>	2005-2015
o.	(3) BRIEF DESCRIPTION AND SPECIFIC ROLE <input type="checkbox"/> Check if project performed with current firm	
	<p><b>Job Duties:</b> The main job duties included protecting the environment, public health, and safety of residents through permit, inspection, consultation, planning, investigation and enforcement activities in a wide variety of program areas including water quality, recreational health, land use, site assessment and mitigation, solid waste, hazardous materials, food, and housing. The primary job duties were focused on site inspections confirming compliance with federal, state, and local environmental health codes, laws, and regulations. Facilities inspected included clear water wells, water distribution systems, hazardous waste generators and storage facilities, wastewater treatment plants, landfills, hospitals</p>	



and medical clinics, public swimming facilities, rental properties, camps, on-site sewage disposal systems, and solid waste recycling centers.

Additionally, new construction plans, and specifications were reviewed to ensure compliance to federal, state, and local environmental health codes, laws, and regulations.

**The scope of work included:** Quality assurance, facility inspection, code, law and regulation enforcement, and building/ plan review and approval.

**Role: On site superintendent/ Environmental Health Inspector**



NAME			ROLE IN THIS CONTRACT			YEARS EXPERIENCE	
<b>Steven Yates</b>			<b>Project Manager</b>			a. TOTAL <b>40+</b>	b. WITH CURRENT FIRM Less than 1yr
FIRM NAME AND LOCATION							
Hal Hays Construction, Inc., Riverside, CA							
EDUCATION							
<ul style="list-style-type: none"> <li>▪ BA Financial Management, California State University, Sonoma</li> <li>▪ State of California contractor's license classifications A, B, C36, C53 (retired)</li> </ul>							
OTHER PROFESSIONAL QUALIFICATIONS							
<p>Mr. Yates has extensive experience in in Department of Defense, Government, DOT, Public and Private work sector related to design build, building construction and heavy civil construction. He maintains specific experience in project work areas such as: demolition; site work; grading and excavation; sub-grade preparation; asphalt and concrete paving; striping and signage; utility infrastructure; and work on active military sites</p> <p><b>Software Skills:</b> MS Windows Professional, MS Office Suite, MS Outlook, Primavera CPM Scheduling, SAGE Masterbuilder</p> <p><b>Job Skills:</b> Project Superintendent, Quality Control, Scheduling and Safety Tasks, Safety Regulations, Supervision, Crew Production, Scheduling and Coordinating Subcontractors, Heavy Civil Operations, and Project Management</p> <p>For the following projects, Mr. Yates executed the role of <b>Project Manager</b> including: coordinating meetings and negotiations; recommendation of design and project changes to provide the client the best value for their project; provision of technical oversight for construction start up and testing; implementing subcontracts and purchase orders; and oversight of subcontractor's, supplier's and manufacturer's scheduling. Additional responsibilities include conducting and supervising on-site management staff, assisting in technical submittal reviews, and on-site inspections.</p>							
EMPLOYMENT HISTORY							
2018 - Present	Hal Hays Construction, Inc., Riverside, CA	Project Manager					
2017 – 2017	Balfour Beatty, Los Gatos, CA	Project Manager					
2015 – 2017	Parsons Construction Group, Pasadena, CA	Project Manager					
2011 – 2015	Preston Pipelines, Inc., Milpitas, CA	Division Manager					
2007 – 2011	Mountain Cascade, Inc., Livermore, CA	Division Manager					
1989 – 2006	Mountain Mechanical Contracting, Vacaville, CA	CEO / President					
1985 – 1989	Northwestern Contracting, Sonoma, CA	Vice-President					
1982 – 1984	Northbay Construction, Petaluma, CA	Estimator / Project Manager					
1978 – 1982	Yates Construction, Petaluma, CA	Vice-President					



**RELEVANT PROJECTS**

RELEVANT PROJECTS					
a.	<table border="1" style="width: 100%; border-collapse: collapse;"> <tr> <td style="width: 60%;">(1) TITLE AND LOCATION</td> <td style="width: 40%;">( ) YEAR COMPLETED</td> </tr> <tr> <td><b>San Joaquin Fish Hatchery Expansion</b> Friant, CA</td> <td style="text-align: center;">Ongoing</td> </tr> </table>	(1) TITLE AND LOCATION	( ) YEAR COMPLETED	<b>San Joaquin Fish Hatchery Expansion</b> Friant, CA	Ongoing
	(1) TITLE AND LOCATION	( ) YEAR COMPLETED			
<b>San Joaquin Fish Hatchery Expansion</b> Friant, CA	Ongoing				
<p>(3) BRIEF DESCRIPTION AND SPECIFIC ROLE      <input checked="" type="checkbox"/> Check if project performed with current firm</p> <p>Hal Hays Construction, Inc. (HHCI) served as a prime contractor to the DGS Real Estate Services Division-Department of Fish &amp; Wildlife to construct a new expansion to the San Joaquin Fish Hatchery in Friant, CA.</p> <p>Work scope encompasses (1) New Hatchery Facility: clearing and grubbing, grading, earthwork, construction of a hatchery with research laboratory, fry incubation and production, office space, conference room, equipment and storage rooms, workshop, restrooms, and other spaces, utility building, canopies, and (2) Exterior Hatchery Area: new aeration and filtration tower, outdoor holding tanks, process piping, control systems, chiller, re-circulation equipment, on-site generator, instream/reintroduction access, water main, effluent treatment system, roadways, parking, and site utilities.</p> <p><b>Cost: \$ 16M      Role: Project Manager</b></p>					
b.	<table border="1" style="width: 100%; border-collapse: collapse;"> <tr> <td style="width: 60%;">(1) TITLE AND LOCATION</td> <td style="width: 40%;">( ) YEAR COMPLETED</td> </tr> <tr> <td><b>City of Calabasas Water Upgrade,</b> Calabasas, CA</td> <td style="text-align: center;">2014</td> </tr> </table>	(1) TITLE AND LOCATION	( ) YEAR COMPLETED	<b>City of Calabasas Water Upgrade,</b> Calabasas, CA	2014
	(1) TITLE AND LOCATION	( ) YEAR COMPLETED			
<b>City of Calabasas Water Upgrade,</b> Calabasas, CA	2014				
<p>(3) BRIEF DESCRIPTION AND SPECIFIC ROLE      <input type="checkbox"/> Check if project performed with current firm</p> <p>Construct a new water distribution system consisting of 10,000lf of 36” and 42” wsp in an urban environment. Including, excavation, backfill, removal and replacement of asphalt and concrete paving, welding, pipeline connections to existing systems.</p> <p><b>Cost: \$10M      Role: Project Manager</b></p>					
c.	<table border="1" style="width: 100%; border-collapse: collapse;"> <tr> <td style="width: 60%;">(1) TITLE AND LOCATION</td> <td style="width: 40%;">( ) YEAR COMPLETED</td> </tr> <tr> <td><b>RD1000 River Intake Pump Station,</b> Sacramento, CA</td> <td style="text-align: center;">2010</td> </tr> </table>	(1) TITLE AND LOCATION	( ) YEAR COMPLETED	<b>RD1000 River Intake Pump Station,</b> Sacramento, CA	2010
	(1) TITLE AND LOCATION	( ) YEAR COMPLETED			
<b>RD1000 River Intake Pump Station,</b> Sacramento, CA	2010				
<p>(3) BRIEF DESCRIPTION AND SPECIFIC ROLE      <input type="checkbox"/> Check if project performed with current firm</p> <p>Construct a pump station in the Sacramento River. Project included heavy sheetpile coffer dam, excavation to forty feet deep, concrete work, electrical work, install five 500hp vertical turbine pumps, heavy pipe work, 2000lf 72” welded steel pipe (wsp) discharge to a canal inlet structure.</p> <p><b>Cost: \$28M      Role: Project Manager</b></p>					
d.	<table border="1" style="width: 100%; border-collapse: collapse;"> <tr> <td style="width: 60%;">(1) TITLE AND LOCATION</td> <td style="width: 40%;">( ) YEAR COMPLETED</td> </tr> <tr> <td><b>Bay Division Pipeline</b> San Francisco, CA</td> <td style="text-align: center;">2009</td> </tr> </table>	(1) TITLE AND LOCATION	( ) YEAR COMPLETED	<b>Bay Division Pipeline</b> San Francisco, CA	2009
	(1) TITLE AND LOCATION	( ) YEAR COMPLETED			
<b>Bay Division Pipeline</b> San Francisco, CA	2009				
<p>(3) BRIEF DESCRIPTION AND SPECIFIC ROLE      <input type="checkbox"/> Check if project performed with current firm</p> <p>Construct an interconnect structure with one 72” and two 60” welded steel pipelines. Modify pipelines such that any one pipeline can be rerouted to any other pipeline within the structure. Work included heavy deep shoring, concrete, pipefitting. Electrical. Project was a seismic safety project to assure water availability to SF from any one of three sources.</p> <p><b>Cost: \$ 18M      Role: Project Manager</b></p>					



	(1) TITLE AND LOCATION	( ) YEAR COMPLETED
	<b>Westlands Water District</b> Shafter, CA	2009
e.	(3) BRIEF DESCRIPTION AND SPECIFIC ROLE <input type="checkbox"/> Check if project performed with current firm	
	<p>Construct a pump station and pipeline to connect the terminus of one canal to another. Work included sheetpile coffer dam, dewater, concrete work, install 5 vertical pumps 3@500hp and 2@300hp, excavate lay and backfill 5000lf of 120" RCP pressure pipe, construct canal inlet structure in an active canal.</p> <p><b>Cost: \$ 18M      Role: Project Manager</b></p>	
	(1) TITLE AND LOCATION	( ) YEAR COMPLETED
	<b>San Antonio Pump Station,</b> Tracy, CA	2008
f.	(3) BRIEF DESCRIPTION AND SPECIFIC ROLE <input type="checkbox"/> Check if project performed with current firm	
	<p>Construct a pump station containing five 1000hp splitcase centrifugal pumps, concrete work, heavy electric work, installation of two 1megawatt engine generators, instrumentation and controls.</p> <p><b>Cost: \$ 20M      Role: Project Manager</b></p>	



Hal Hays Construction Inc.			
NAME	ROLE IN THIS CONTRACT	YEARS EXPERIENCE	
		<b>Thomas Vertrees</b>	<b>Superintendent / SSHO / QCM</b>
FIRM NAME AND LOCATION			
Hal Hays Construction, Inc., Riverside, CA			
EDUCATION			
<ul style="list-style-type: none"> <li style="display: inline-block; width: 45%;">▪ CPR &amp; First Aid Training</li> <li style="display: inline-block; width: 45%;">▪ Competent Person</li> </ul>			
OTHER PROFESSIONAL QUALIFICATIONS			
<p>Mr. Vertrees has extensive experience in Department of Defense, Government, DOT, Public and Private work sector related to design build, building construction and heavy civil construction. He maintains specific experience in project work areas such as: <b>demolition; site work; grading and excavation; sub-grade preparation; asphalt and concrete paving; striping and signage; utility infrastructure; and work on active military sites</b></p> <p><b>Software Skills:</b> MS Windows Professional, MS Office Suite, MS Outlook, Primavera CPM Scheduling, SAGE Masterbuilder</p> <p><b>Job Skills:</b> Project Superintendent, Quality Control, Scheduling and Safety Tasks, Safety Regulations, Supervision, Crew Production, Scheduling and Coordinating Subcontractors, Heavy Civil Operations, and Project Management</p> <p>For the following projects, Mr. Vertrees executed the role of <b>Superintendent/Site Safety and Health Officer/Quality Control Manager</b> including: coordinating meetings and negotiations; recommendation of design and project changes to provide the client the best value for their project; provision of technical oversight for construction start up and testing; maintaining day to day project scheduling; executing the construction schedule (CPM); supervising work force and subcontractors; implementing safety programs and procedures; preparation of AHAs; site inspections; advising management of any deficiencies; safety training; accident investigation and reporting; safety inspection to ensure compliance; and maintaining Quality Control information on a daily basis, including the Contractor Quality Control (CQC) Plan elements, such as: quality control organization, definable features of work, submittal register, QC requirements, equipment list, Daily CQC Report, QC punch list items, QC testing, transferred and installed property, and user training requirements. Additional responsibilities include conducting and supervising on-site management staff, assisting in technical submittal reviews, and on-site inspections. Additional responsibilities include conducting and supervising on-site management staff, assisting in technical submittal reviews, and on-site inspections</p>			
EMPLOYMENT HISTORY			
2018 - Present	Hal Hays Construction, Inc., Riverside, CA	Superintendent/SSHO/QCM	
1983 - 2018	Vertrees Construction, Ripon, CA	Owner	



**RELEVANT PROJECTS**

RELEVANT PROJECTS					
a.	<table border="1" style="width: 100%;"> <tr> <td style="width: 70%;">(1) TITLE AND LOCATION</td> <td style="width: 30%;">( ) YEAR COMPLETED</td> </tr> <tr> <td><b>STK – 03 Tank and Booster Site Improvements</b> Stockton, CA</td> <td style="text-align: center;">Ongoing</td> </tr> </table>	(1) TITLE AND LOCATION	( ) YEAR COMPLETED	<b>STK – 03 Tank and Booster Site Improvements</b> Stockton, CA	Ongoing
	(1) TITLE AND LOCATION	( ) YEAR COMPLETED			
<b>STK – 03 Tank and Booster Site Improvements</b> Stockton, CA	Ongoing				
(3) BRIEF DESCRIPTION AND SPECIFIC ROLE <input checked="" type="checkbox"/> Check if project performed with current firm  This project scope of work consists of: Furnish all labor, tools, equipment, transportation and material to grade site including demolition, clearing, and grubbing, final grading, construction of 100x120 detention basin; <b>Demo</b> of concrete pad, and booster pump; <b>Grading and Site</b> preparation including all import/export; Installation of ductile iron piping; Installation of PVC SDR 35 <b>Storm drain piping</b> ; Construction of concrete channel including grates and flush type cleanout; Electrical; Construction of Detention Basin  <b>Cost: \$ 1.7M                      Role: Superintendent/QCM/ SSHO</b>					
b.	<table border="1" style="width: 100%;"> <tr> <td style="width: 70%;">(1) TITLE AND LOCATION</td> <td style="width: 30%;">( ) YEAR COMPLETED</td> </tr> <tr> <td><b>Home Remodel</b> Castro Valley, CA</td> <td style="text-align: center;">2017</td> </tr> </table>	(1) TITLE AND LOCATION	( ) YEAR COMPLETED	<b>Home Remodel</b> Castro Valley, CA	2017
	(1) TITLE AND LOCATION	( ) YEAR COMPLETED			
<b>Home Remodel</b> Castro Valley, CA	2017				
(3) BRIEF DESCRIPTION AND SPECIFIC ROLE <input type="checkbox"/> Check if project performed with current firm  This project was home remodel in Ripon, CA. The project consisted of a two story addition at side of house, 2133 sq. ft. which includes 2 bedrooms, family room, office and 2 bathrooms. adding 3 car garage, 713 sq. ft., which is below the office. remodel 500 sq. ft. which is the existing kitchen and existing bathroom. when project is completed, the house will be 4 bedrooms and 3 bathrooms. demo existing detached secondary unit 627sf.  <b>Cost: \$                      Role: Superintendent</b>					



---

## Appendix A-2

Professional Resumes for  
**CAW Monterey Peninsula Water Supply Project  
Design Build of Fitch Park ASR Wells 5 & 6 Above  
Ground Facilities **Luhdorff & Scalmanini,  
Consulting Engineers** Project Design Team.**

# Justin M. Shobe, P.E. Supervising Engineer

---

## **Specialization:**

Fourteen years of professional experience in civil engineering and water resources consulting for public and private entities. Specific project experience includes: preparation of drawings and technical specifications for water production, pumping, storage and treatment facilities; management of municipal construction projects; preparation of water system master plans and hydraulic distribution system analysis; completing public water system permits; completing USDA and SRF grant funding applications; and providing overall technical guidance and oversight of treatment facility and pumping equipment evaluations. Knowledge and expertise of deep well vertical turbine pumps; split case and can booster pumps; surface water treatment; iron and manganese filtration systems; nitrate and hexavalent chromium removal; pump performance testing; water storage and booster stations; water distribution and transmission pipelines; chemical disinfection systems including liquid sodium hypochlorite, calcium hypochlorite tablet chlorinators and onsite electrolytic chlorine generation.

## **Professional Registration:**

CA Registered Professional Civil Engineer, No. 77669

## **Academic Degrees:**

B.S., Environmental Resources Engineering (ABET accredited)  
Humboldt State University, Arcata, California 2007

## **Professional Experience:**

Luhdorff and Scalmanini Consulting Engineers, Inc., Woodland, CA <i>Supervising Engineer</i>	2007 to Present
City of Eureka, Engineering Department, Eureka, CA <i>Engineering Intern</i>	2007 - 2008
Humboldt County Division of Environmental Health, Eureka, Ca <i>Environmental Health Technician</i>	2005 - 2007

## **Representative Professional Assignments:**

- District Water Engineer for Town of Discovery Bay Community Services District – Mr. Shobe is the acting District Water Engineer for the Town of Discovery Bay Community Services District, which is a water system serving potable water to a population of 16,000 residents through 5,500 water service connections. Program Manager for the Town’s Water Meter Installation Project of over 3,500 water meters in an 8-month period. Managed the Town’s conversion of PLCs and SCADA system at the Willow Lake Water Treatment Plant. Attends Water and Wastewater Committee Meetings with the Town’s Board and Staff and participates and delivers presentations to the Board of Directors as needed. Town of Discovery Bay Community Services District, CA.
- City of Merced Well 20 – Project Manager/Engineer of Record for the City of Merced’s newest water supply well, which is an 1,800 gallon per minute station with chemical treatment. The facility is housed in a CMU block building situated on a 0.5-acre parcel. A 2-acre storm water drainage basin was designed to receive, store, and infiltrate storm water runoff and well overboard pumping from the site. Project includes CEQA documentation, design basis, well construction oversight, design plans and specifications for a complete mechanical, structural and electrical design of the new pump station.

---

**Representative Professional Assignments (cont.):**

- Blue Lake Springs 2014 Water Master Plan – Project Manager and lead engineer in the evaluation of a water system and preparation of a Water Master Plan serving a population of 6,000 residents. Gathered and reviewed all water system records; characterized water demand and growth; assessed water supply capacity, system storage, water treatment operation, and telemetry systems; evaluated regulatory compliance; developed a water system hydraulic model as a tool to evaluate 16-mile pipeline replacement and prioritization schedule for substandard and back-lot mainlines; prepared technical memoranda, Draft and Final reports, Capital Improvement Plan, and held townhall meetings to present the work to the public and the board of directors. Following the Water Master Plan, Mr. Shobe lead the effort to conduct a Pressure Zone Study to define all critical zone improvements, PRV stations and transmission mains associated with a 16 mile replacement and relocation pipeline project. Blue Lake Springs Mutual Water Company, CA.
- El Prado Well Pump Station Upgrades – Project Manager/Engineer of Record for well rehabilitation and design a new pump station facilities at a 40 year old owned by the Sacramento Suburban Water District. Upgrades consisted of converting the well from a vault to an above ground completion, evaluating well performance and video logs, conducting well rehabilitation and modifications, and re-design the entire site in terms of pumping equipment, above ground piping, chemical systems, control panels, site paving and utility connections. Project was completed on time and within budget. Project included design plans, permitting, soliciting contractor bids, contract award, construction meetings and submittals, inspections, startup and commissioning and contract closeout. Sacramento Suburban Water District, CA.
- Tait Well Field Water Supply Project – Project Manager/Engineer of Record, for installation of City of Santa Cruz water supply facilities pulling underflow from the San Lorenzo river through a shallow well field, including two new shallow well pump station installations and rehabilitation of an existing shallow well. Project involved development of a design basis, water supply permitting, plans and specifications for well pump stations, electrical MCC systems and site improvements. Performed solicitation of bids and construction management, held weekly meetings, resolved conflicts with drawings and field conditions, reviewed submittals and performed field inspection and testing. City of Santa Cruz, CA.
- Beltz Well #12 Iron and Manganese Treatment Plant – Project Engineer, prepared a research document on iron and manganese treatment alternative technologies, prepared a design basis report, prepared design drawings and specifications for a 75 horsepower well pump, filter system, welded steel backwash tanks, onsite sodium hypochlorite generation facilities, control building and site improvements. Performed solicitation of bids and construction management, held weekly meetings, resolved conflicts with drawings and field conditions, reviewed submittals and performed field inspection and testing. City of Santa Cruz, CA.
- 2013 Groundwater Transfer Project – Project Engineer, developed and executed a Groundwater Substitution Water Transfer program proposal that included a monitoring and evaluation plan for transfer and post-transfer periods and a mitigation response program. Project was regulated and approved by the Department of Water Resources. Anderson Cottonwood Irrigation District, Anderson, CA.
- River Island Surface Water Treatment Plant – Project Engineer, prepared design drawings and specifications for a 500 gpm surface water treatment plant, raw water conveyance system, two-500,000 gallon bolted storage tanks, site improvements. Worked with environmental consultant (Inland Ecosystems) on preparation of initial study and permitting. Del Oro Water Company, CA.

---

**Representative Professional Assignments (cont.):**

- Discovery Bay 2012 Water Master Plan – Project Engineer, evaluated water system and prepared a Water Master Plan serving a population of 16,000 residents, including: water demands, supply capacity, storage capacity, water quality, iron and manganese treatment plant, booster plants; assessed condition of equipment; evaluated regulatory compliance; developed water system hydraulic model and evaluated distribution system performance; prepared Draft and Final technical reports with a Capital Improvement Plan. Town of Discovery Bay, CA.
- Water System Engineer - Pillar Ridge Mobile Home Park – Acting water system engineer for a Small Water System permitted by the California Department of Public Health. System includes 227 service connections (1,000 residents), three water supply wells at 20 gpm each, iron and manganese treatment facility, two 70,000 gallon storage reservoirs, booster pumps and hydropneumatic tank, 8-inch and 6-inch pipelines in the distribution system. Millennium Housing, CA.
- Proposition 50 Groundwater Project – Project Engineer, three new water supply wells and pump stations, prepared design drawings and specifications, provided construction management, ensured compliance with governing environmental documents, provided onsite performance testing and provided labor compliance reporting.
- North State Street Pipeline Project – Project Engineer, prepared design drawings and specifications and provided construction management for a 1-mile 16-inch pipeline in public county ROW in a commercial, highly trafficked-setting. Millview County Water District, Ukiah, CA
- Well 6 Pump Station – Project Engineer, prepared design drawings and specifications and provided construction management of a 2,000 gpm well pump station with pipeline tie-in, electrical controls and iron and manganese treatment. Town of Discovery Bay, CA
- Pines Pipeline Projects – Project Engineer, performed field surveying, prepared base map and prepared design drawings and specifications for 2 miles of 8-inch pipeline replacement in rural and urban-residential setting. Del Oro Water Company, CA.
- Millview County Water District Water Master Plan – Staff Engineer, evaluated water system serving a population of 5,500 residents, including: water demands, supply capacity, storage capacity, water quality, surface water treatment (shallow well supplies, clarifiers, filters, chemical dosing and clearwell C-T), booster plants, and distribution system. Specific tasks included: assessed condition of equipment; evaluated regulatory compliance with supply, treatment and distribution; developed water system hydraulic model and evaluated distribution system performance; prepared Draft and Final technical reports with a Capital Improvement Plan. Millview County Water District, Ukiah, CA.
- Burbank Park Well Pump Station – Staff Engineer, prepared design drawings and specifications and provided construction management of a 2,000 gpm, 200 horsepower well pump station, provided onsite field testing, oversaw well re-habilitation, conducted water quality analysis. City of Merced, CA.
- Bonita Well Pump Station – Staff Engineer, prepared design drawings and specifications and provided construction management of a 2,500 gpm, 250 horsepower well pump station and treatment plant including onsite chlorine generation, provided onsite field testing, oversaw construction and testing. Citrus Heights Water District, CA.
- Verner Avenue Well and Treatment Facility - Staff Engineer, prepared design drawings and specifications and provided construction management of a 1,200 gpm, 125 horsepower well pump station, provided onsite field testing, oversaw construction and provided field testing and start-up services. Sacramento Suburban Water District, CA.

# William A. Gustavson

## Principal Engineer

---

### **Specialization:**

Forty-nine years of experience in groundwater and surface water development, including design, preparation of plans and specifications, construction inspection, and project management of: water wells, including well rehabilitation; pump stations for deep well (vertical lineshaft and submersible) application; booster pump applications; lake and river intake pumps; auxiliary power systems; telemetry and instrumentation including SCADA systems; chemical feed systems; surface and groundwater treatment systems; water storage and distribution systems; water master plans; and water distribution computer models. All work is for municipal, industrial and agricultural industries with the work performed in the states of California, Oregon, Nevada, Washington, Idaho and Montana. Extensive work in conjunction with various federal, state and county agencies for compliance with regulations pertaining to the water purveying industry.

### **Academic Degrees:**

Water Treatment Plant Operation - California State University, Sacramento, CA	1995
Civil Engineering Major, Sacramento State University, Sacramento, CA	1970 - 1971
A.A. Degree, Physical Science - General, American River College, Carmichael, CA	1970

### **Past Professional Certification:**

State of California Water Treatment Plant Operator, Grade T-3, No. 0799  
AWWA Water Distribution Operator, Grade D2, No. 3567

### **Professional Experience:**

Luhdorff and Scalmanini, Consulting Engineers Inc., Woodland, CA Vice President and Principal Project Manager	2007 to Present
Luhdorff and Scalmanini, Consulting Engineers, Woodland, CA Principal Project Manager	1991 to 2007
Luhdorff and Scalmanini, Consulting Engineers, Woodland, CA	1980 - 1991
Layne-Western Co., Inc. (formerly E.E. Luhdorff Company), Moses Lake, WA Sales Engineer	1976 - 1980
E.E. Luhdorff Co., Inc., Woodland, CA and Moses Lake, WA Job Coordinator & Engineering Assistant	1975 - 1976
Citizens Utilities Company of California, Sacramento, CA Assistant System Engineer	1968 - 1975

---

**Representative Professional Assignments:**

- Designed and managed the installation of numerous chlorination and fluoridation stations and several iron and manganese removal water treatment plants, small surface water treatment systems, including site improvements (drainage, paving, etc.), electrical systems, security structures, storage tanks, piping and other conveyance systems, and pumping facilities. Duties also included instruction on the operation, record keeping, and maintenance of the facilities.
- Extensive work with various regulatory agencies; including preparation for California Public Utility Commission rate hearings; adhering to regulations concerning the construction and operation of water wells, pumping stations and water treatment plants; preparing encroachment permits for work within public right-of-ways; filing applications under the California Environmental Quality Act; establishing State certified water distribution systems; and amendments to public water supply permits.
- Designed and managed numerous regional water quality monitoring programs for water well and surface water supplies in conformance with state and federal drinking water standards. Other duties included the design of groundwater sampling equipment.
- Designed, inspected and managed the installation and/or replacement of numerous water distribution and storage systems throughout the State of California. Duties also included network analysis of various distribution systems for planning, operational, or design purposes.
- Designed, inspected and managed the installation, replacement and/or repair of numerous pumping stations. Work included specifying performance and equipment parameters for deep-well vertical turbine lineshaft and submersible pumps, short-coupled service pumps, end-suction and split-case centrifugal booster pumps, and slant-mounted river pumps. Duties also included the design and project management of all pumping station support equipment such as the station piping, electrical and telemetry systems, site security, building, chemical feed equipment, paving, drainage, and auxiliary power supplies.
- Conducted and/or managed numerous well and aquifer and pump performance tests.
- Designed, inspected and managed the construction, development, and testing of numerous production, injection and monitoring wells in various geological settings throughout the western United States.
- Designed and managed numerous water well rehabilitation projects, including treatment programs to restore the yield of wells affected by iron, sulfate, and slime-forming bacteria. Well modification programs have included the repair of wells with excessive sand production, structural failures, and degraded water quality.

**Professional Affiliations:**

American Water Works Association  
Sacramento Area Water Works Association - Past Chairman, Well Testing Committee  
Groundwater Resources Association of California

---

**Teaching Activities:**

- **Wells and Pumps; Sacramento Suburban Water District;** Instructor on pumping station and well design and operation considerations. (2005 to current).
- **Wells and Pumps; Monterey County Water Agencies;** Instructor on pumping station and well design and operation considerations. (2012).
- **Wells, Pumps and Variable Frequency Drives;** Instructor on pumping station design considerations and the implementation of variable speed drives (1992).
- **Small Water System Operations; American Water Works Association,** Instructor on water well construction techniques (four classes, Spring 1990).
- **Water Distribution Operator Class; Sacramento Area Water Works Association,** Instructor on well pumps, hydraulics and instrumentation (Fall 87 to 2005).
- **Well and Pump Technology; University of California, Davis Extension,** Instructor on pump efficiency testing procedures (April, 1988).
- **Washington State Department of Ecology (1980),** Instructor for one-day course on well drilling, well testing, pumped well efficiency, and vertical and axial pumps.
- **Washington State Well Driller's Association (1980),** Speaker at a seminar on "Proper Implementation and Construction of Sanitary Well Seals."
- **Federal Land Bank, Moses Lake, Washington (1979),** Instructor for discussion on proper methods of well drilling as they apply to geologic conditions.
- **Washington State University, Pullman, Washington (1979),** Instructor for seminar on "Drilling Procedures Used in the Construction of Water Wells in the Columbia River Basalt Group."

# Thomas D. Elson

## Senior Principal Engineer

---

### **Specialization:**

Thirty-eight years of professional experience including 27 years in groundwater consulting with Luhdorff & Scalmanini and 11 years with Chevron Corporation. Representative assignments include planning and managing groundwater exploration projects, conducting water supply site assessments, CEQA studies, water well design, and well construction and testing. Conducts studies of groundwater impacts for CEQA studies and has served as an expert witness on water well performance and groundwater seepage. Prior to joining Luhdorff and Scalmanini, Mr. Elson worked for Chevron as a research engineer, production engineer, and as a regional reservoir engineer. Mr. Elson is a Co-Instructor at University of California, Davis Extension for Groundwater Law and Hydrology.

### **Academic Degrees:**

M.S., School of Earth Sciences (Petr. Engr.) Stanford University	1979
B.S., School of Earth Sciences (Petr. Engr.) Stanford University	1976

### **Professional Experience:**

Luhdorff & Scalmanini Consulting Engineers <i>Principal (2008-present)</i> <i>Senior Engineer (1990-2007)</i>	1990 to Present
Chevron U.S.A., Inc. <i>Senior Reservoir Engineer (1988-90)</i> <i>Reservoir Engineer (1985-87)</i> <i>Production Engineer (1983-85)</i>	1983 - 1990
Chevron Oil Field Research Company <i>Research Engineer</i>	1979 - 1983

### **Representative Professional Assignments:**

- **Water Supply** – Water supply assessments to identify target aquifers, assess yield, and well field planning. Clients include municipalities, water districts, and private entities.
- **Groundwater Management** – Provide technical assistance SGMA related studies. Was Technical Supervisor for a groundwater banking project in the San Joaquin Valley.
- **Well Design** – Project Manager for design and construction oversight of municipal, industrial, and agricultural water supply wells.
- **Well Rehabilitation** – Expert on water well problems, including evaluation of well and pump efficiency, and a wide variety of rehabilitation programs to address such problems as sand production, biofouling, and adverse water quality impacts due to commingling.
- **Injection Wells** – Has designed wells and well networks for conjunctive use and water reuse applications and prepared permit applications for EPA Class I and II injection wells.
- **Environmental Studies** – Has conducted groundwater studies for project impact analysis under CEQA. Projects include new wells and well fields, water reuse, and conjunctive use projects.
- **Groundwater Seepage** – Evaluations of groundwater seepage and provides expert witness.
- **Aggregate Mining** – Reserves estimates and assessments of mining impacts on groundwater.

---

### ***Teaching and Presentations:***

Society for College and University Planning, 2015 Pacific Regional Conference, "Ground Source Geothermal Systems: Sustainability from the Ground Up - Stanford University's plans for district-scale open loop ground source geothermal for heating and cooling," Co Presenter, March 24, 2015.

University of California, Davis Extension, "California's 2014 Groundwater Legislation," Co-Presenter, October 31, 2014.

Western US Irrigation Water Conference, Division of Agriculture and Natural Resources, "Groundwater Well Compliance Issues" Co Presenter, April 25, 2014.

California Water Law and Policy, Faculty, April 23, 2013.

University of California, Davis Extension, Groundwater Law and Hydrology, Co-Instructor, 2011-present.

Groundwater Resources Association of California, Managing Wells in California Protecting Groundwater Resources, Presentation, "Production Rate Decline: Aquifer, Well, and/or Pump Problem?" August 28, 2012.

AWWA Conference – Sustainable Water Sources, February 11, 2008  
"Initiation of Conjunctive Use – Well Utilization Project" – Co Author.

University of California, Davis: Hydrologic Lecture Series, March 30, 2006  
"Regional Groundwater Resources Assessment in Yolo County" – Co Presenter.

University of Southern California (1980-83)  
Graduate Course: Well Completions and Stimulation – Instructor.

### ***Technical Papers and Patents:***

"The Effectiveness of Foaming Agents at Elevated Temperatures Over Extended Periods of Time," Society of Petroleum Engineers of AIME, 1978.

"Phase Separation of Two-Phase Fluid in an Injection Wellbore" SPE Preprint 1981 & Second International Conference on Heavy Grade and Tar Sands, 1982.

"High Angle Gravel-Pack Completion Studies," Journal of Petroleum Technology, 1984.

"Field Application of Clean Completion Fluids," Society of Petroleum Engineers of AIME, 1985.

"Foam Gravel Packing in Highly Deviated Well," U.S. Patent 4,460,045

"Foam Gravel Packing," U.S. Patent 4,438,815

"Steam Injection Well Gravel Pack Material of Sintered Bauxite," U.S. Patent 4,537,254

### ***Professional Affiliations and Committees:***

Groundwater Resources Association of California

Stakeholders Advisory Group for California Department of Water Resources Geothermal Heat Exchange Well Updated Standards Project, 2013.

Task Group on Evaluation of Gravel Packing Materials to revise "API Recommended Practices for Testing Sand Used in Gravel Packing Operations" – Past Member.

# Jason M. Coleman

## Senior Engineer

---

### **Specialization:**

Ten years' experience in well pump station, water distribution and water treatment design and related construction management. Experience includes engineering design of vertical turbine and submersible deep well pumps, booster pumps, pipeline distribution systems, storage tanks, surface water and ground water treatment facilities including preparation of engineering drawings and specifications for construction. Knowledge of telemetry and instrumentation, controls, and programming logic of chemical treatment and pumping systems. Construction management inspection services performed for numerous well pump station, pipeline, water treatment and storage tank projects including direction in construction meetings, development of agendas and meeting minutes. Provided technical review and management of payment applications, submittals, RFIs, change orders and record drawings. Experience with regulatory agencies includes preparation of water supply permits, drinking water source assessments, water use permits, system operation plans and emergency response plans, TMF reports and CEQA studies.

### **Professional Registration:**

CA Registered Professional Civil Engineer #78366 2011

### **Academic Degrees:**

B.S., Civil and Environmental Engineering 2008  
Minor, Atmospheric Science  
University of California: Davis

### **Professional Experience:**

Luhdorff & Scalmanini Consulting Engineers, Inc. Woodland, California  
*Senior Engineer* 2017 to Present  
*Project Engineer* 2011 to 2017  
*Staff Engineer* 2008 to 2011  
  
Kaweah Construction Company, West Sacramento, California  
*Engineering Intern* 2007 to 2008

### **Professional Affiliations:**

American Society of Civil Engineers #497173 2005 to 2013  
American Water Works Association #01179332 2012 to Present  
Groundwater Resources Agency #4497 2013 to Present  
American Council of Engineering Companies (ACEC) 2017 to Present

### **Representative Professional Assignments:**

Preparation of civil, mechanical drawings and technical specifications, technical assistance in review and management of project records and submittals and inspection services conducted during construction for the following projects:

- Well Pump Stations A, B, C, Santa Clara Valley Water District, Campbell CA  
*Provided construction administration including field site inspections, technical review of RFIs, change orders, and submittals for construction of three well pump stations including two deep well submersible pumps rated at 1,200 gpm and one vertical turbine pump rated at 1,200 gpm. Performed pump station startup activities and assisted with development of new SCADA system.*

---

### **Representative Professional Assignments (cont):**

- Diana Park Avenue Well Pump Station, City of Morgan Hill, Morgan Hill CA  
*Prepared design drawings and specifications and provided construction management of a new 900 gpm, 75 horsepower well pump station, provided onsite field testing, oversaw construction and provided field testing and start-up services.*
- Regional Intertie Project, Del Oro Water Company, Magalia CA  
*Provided construction administration including field site inspections, technical review of RFIs, change orders, and submittals for construction of a 13,500 lineal feet of 16" PVC transmission line, a 350,000 gallon bolted steel transfer tank, a 300 gpm pressure clarifier/filter treatment system and new SCADA system. Performed water treatment system startup activities and assisted with development of new SCADA system.*
- Upper Dymond Storage Tank, Del Oro Water Company, Strawberry CA  
*Prepared design drawings and specifications and provided construction management for a 164,000 gallon bolted steel storage tank and ringwall foundation, oversaw construction and provided onsite field inspections.*
- Stonecreek Well Pump Station, Diablo Water District, Oakley CA  
*Prepared design drawings and specifications and provided construction management of a 2 MGD, 200 horsepower well pump station, provided onsite field testing, oversaw construction and provided field testing and start-up services. Directed weekly construction progress field meetings, provided technical review of RFIs, change orders, and submittals.*
- Transfer Tank Project, Clear Creek Community Services District, Happy Valley CA  
*Prepared design drawings and specifications and provided construction management for a 350,000 gallon bolted steel transfer tank and ringwall foundation, oversaw construction and provided onsite field inspections.*
- Bodega Well Pump Station, City of Pittsburg, Pittsburg CA  
*Prepared design drawings and specifications and provided construction management of a new 1,300 gpm, 100 horsepower well pump station, provided onsite field testing, oversaw construction and provided field testing and start-up services.*
- Mainline Replacement Project, Tanimura & Antle, Spreckels CA  
*Prepared design drawings and specifications and provided construction management for installation of 2.2 miles of distribution piping with 6" and 8" mainlines including service connection tie-ins to approximately 400 customers, oversaw construction and provided onsite field inspections.*
- Water Meter & Backflow Installation Project, Tanimura & Antle, Spreckels CA  
*Prepared design drawings and specifications and provided construction management for new installation of approximately 30 backflow preventer devices throughout the distribution system including installation of approximately 175 new water service meters, oversaw construction and provided onsite field inspections.*
- Water Master Plan, Millview County Water District, Ukiah CA  
*Performed evaluation of water demand, source capacity and storage capacity of existing water system with approximately 1,600 service connections. Performed assessment of existing treatment system and distribution system and evaluated compliance with regulatory requirements.*

# Philip L'Amoreaux, E.I.T.

## Project Engineer

---

### **Specialization:**

Mr. L'Amoreaux has nine years of experience in well pump design, water distribution system analysis and construction management. Performed hydraulic calculations, preparation of technical specifications for well pump design, construction submittal reviews, weekly construction meetings, development of agendas and meeting minutes. Experience with hydrogeologic modeling for the layout design of a well field, groundwater pumping management and water quality issues. Knowledge of hydrologic watershed and streamflow analysis for purposes of flood management, water quality and sediment transport modeling. Time series generation by stream gage analysis. Field work includes groundwater quality sampling, river sediment collection and pebble counts.

### **Academic Degrees:**

University of California: Davis M.S., Civil and Environmental Engineering Water Resources Graduate Group	2012
University of California: Davis B.S., Civil and Environmental Engineering	2009

### **Professional Registration:**

CA Engineer in Training #134465	2009
---------------------------------	------

### **Professional Experience:**

Luhdorff & Scalmanini Consulting Engineers, Inc. Woodland, California <i>Project Engineer</i>	2013-2017
<i>Staff Engineer</i>	2017-Present
Hydrologic Engineering Center, U.S. Army Corps of Engineers, Davis, California <i>Engineering Intern</i>	2009-2011

### **Representative Professional Assignments:**

- Preparation of environmental investigation report, groundwater management report, hydraulic calculations and pump selection, technical review of construction submittals for the following projects:
  - Mendota Pool Group, Groundwater Management, EIS/EIR
  - San Francisco Public Utilities Commission, Groundwater Storage and Recovery Project
  - City of Santa Cruz, Beltz Well 12 Water Treatment Plant
  - Town of Discovery Bay, Well No. 7 Pump Station

# Kaleisha D. Miller, E.I.T.

## Staff Engineer

---

### **Specialization:**

Ms. Miller is a recent civil engineering graduate with a background in water and wastewater. Her experience includes well pump design, raw water pipeline and booster pump station performance evaluation, construction management, and water supply permitting. She has knowledge of on-site generated low-strength hypochlorite systems and the resulting chlorate production. Field work includes slope stability measurements, collection of hypochlorite samples from water treatment plants, forensic investigation of RCCP pipe, and zebra mussel counts. Her duties include preparing engineering reports, permit applications, hydraulic calculations, and design drawings, and reviewing construction submittals and RFI's.

### **Academic Degrees:**

Honors B.S., Civil Engineering *Summa Cum Laude*, University of Texas at Arlington 2016

### **Professional Registration:**

CA Engineer in Training #161374 2017

### **Professional Experience:**

Luhdorff & Scalmanini Consulting Engineers, Inc. Woodland, California  
*Staff Engineer* 2017-Present

Garver, LLC, Fort Worth, Texas  
*Engineering Intern* 2016-2017

Tarrant Regional Water District, Fort Worth, Texas  
*Engineering Intern* 2016-2016

### **Representative Professional Assignments:**

- Palm Well and Water Treatment Plant, Sacramento Suburban Water District, Sacramento CA  
*Prepared design drawings and designed aspects of the well pump station and water treatment plant including the well pump, backwash tank, reclamation pump, recirculation pump, and sewer improvements. Worked with local agencies to determine requirements and necessary permits.*
- Boys Ranch and Jackson Pump Stations, City of Morgan Hill, Morgan Hill CA  
*Provided construction administration assistance through the technical review of RFIs and submittals for the construction of two pump stations including two vertical turbine pumps rated at 800 gpm and 600 gpm.*
- Alforex Seeds Water Treatment Plant, Alforex Seeds LLC, Woodland CA  
*Preparation of water quality reports, CEQA documentation, chemical monitoring plans, and other documentation for the Alforex Seeds Water System domestic water supply permit amendment.*
- San Francisco Public Utilities Commission, Groundwater Storage and Recovery Project, San Francisco Public Utilities Commission, San Francisco, CA  
*Participated in overall pumping efficiency (OPE) testing at multiple sites and evaluated results. Provided construction administration oversight during well pump installation.*

# Allison B. Cronk, E.I.T.

## Staff Engineer

---

### **Specialization:**

Ms. Cronk is a recent environmental engineering graduate with a background in water, storm water management, and environmental practice. Her experience includes water distribution system expansion, storm water practice inspection and reporting, watershed analyzation, septic system design, trail design, and creating and editing drawings in AutoCAD. She has knowledge of permit compliance under NEPA and environmental impact analysis, ecological engineering practices, wastewater treatment, solid waste management, and geotechnical engineering. Field work experience includes percolation tests, soil analysis, and SWPPP inspections. Her duties include drafting and editing engineering plans, reviewing storm water permits and standards, assisting with site plans, performing engineering calculations, and reviewing submittals, specifications and design drawings.

### **Academic Degrees:**

B.S., Environmental Resources Engineering, *Magna Cum Laude* 2017  
State University of New York College of Environmental Science and Forestry

### **Professional Registration:**

Envirocert Certified Professional in Erosion and Sediment Control – In Training #8663 2017  
California Engineer in Training 2017

### **Professional Experience:**

Luhdorff & Scalmanini Consulting Engineers, Inc. Woodland, California 2017-Present  
*Staff Engineer*

T.G. Miller Engineers and Surveyors, P.C. Ithaca, New York 2016-2017  
*Engineering Intern*

### **Representative Professional Assignments:**

- Prepared a site grading plan and assisted with design drawings for a groundwater pump station in AutoCAD
- Assessed the hydrologic and ecological conditions of low-flow canal and presented solutions for ecological enhancements, increased flow opportunities, and a trail design along the canal
- Performed calculations, a cost estimate, and analysis for a water distribution system expansion including a list of user name and property types, system sizing, and water district updates in AutoCAD
- Technical writing projects including inspection reports on storm water management practices for municipal use and design reports
- Designed erosion and sediment control plans, construction sequences, maintenance plans, and permanent storm water management practices in accordance with New York State Standards

# Greg Garrison, G.I.T. Staff Engineer

---

## **Specialization:**

Mr. Garrison has seven years' experience in project and construction management and groundwater engineering. His experience includes planning, estimating, scheduling, designing, analyzing and construction for pump stations, groundwater modeling, high school modernization, creek restoration, gas transmission systems, a superfund site, demolition, and hazardous material remediation. His duties include preparing, designing, analyzing and reviewing the generation of engineering reports, permits, change orders, schedules, design drawings, submittals and engineering calculations.

## **Academic Degrees:**

M.S., Civil and Environmental Engineering, San Jose State University Concentration: Water Resources Engineering Minor: Environmental Engineering	2015
B.S., Civil and Environmental Engineering, San Jose State University	2012

## **Professional Registration:**

OSHA 40 Hour HAZWOPER Training	February 2017 – February 2018
CA Engineer in Training #153353	2014

## **Professional Experience:**

Luhdorff & Scalmanini Consulting Engineers, Inc., Woodland, California Staff Engineer	2016 – Present
Pacific States Environmental Contractors, Dublin, California Project Engineer	2015 – 2016
E2 Consulting Engineers, Inc., Emeryville, California Project Engineer	2014 – 2015
Obayashi Corporation, Burlingame, California Office Engineer	2013
Storm Water & Sanitary Sewer Division, City of San Jose DOT, San Jose, California Storm Water & Sanitary Sewer Engineer Trainee	2012 – 2013
Swinerton Builders, Santa Clara, California Intern Project Engineer	2011

## **Representative Professional Assignments:**

- Performing civil engineering and assist in project management for well head treatment, potable water wells pump stations, pipelines, and storage facilities.
- Support of municipalities and water districts with the development of water master plans, capital improvement programs, pipeline assessment programs, and urban water management plans.
- Generate technical drawings and plan sets using computer aided drafting system, (AutoCAD 2017).
- Responsible for preparing plans for construction sites, pump stations, master plans, and various water wells plan sets.
- Generate, analyze, and manage spatial and geographical data using geographical information system, (ArcGIS).

---

**Representative Professional Assignments (cont.):**

- Generate, analyze, manipulate, and manage spreadsheets, tables, formulas, queries and reports while using Microsoft Excel and Microsoft Access.
- Generate, analyze and manage project schedules using Microsoft Project for Bid Proposals.

**Projects:**

**Big Canyon Well Station, Callayomi County Water District, Middletown, CA**

- *Prepared the Drinking Water Source Assessment and Protection (DWSAP) report*
- East Main #1 Pump Station, City of Morgan Hill, CA
- *Prepared design drawings and reviewed submittals.*

**Groundwater Storage & Recovery Project, San Francisco Public Utilities Commission, San Francisco, CA**

- *Provided construction administration for pump installations and discharge head alignment field site inspections.*

**Groundwater Supply Phase 1, San Francisco Public Utilities Commission, San Francisco, CA**

- *Prepared the Drinking Water Source Assessment and Protection (DWSAP) reports for the Golden Gate Central Well Station, Lake Merced Well Station, South Sunset Well Station and West Sunset Well Station.*

**Jackson Well #3 Pump Station, City of Morgan Hill, CA**

- *Prepared design drawings and reviewed submittals.*

**Palm Well Pump Station, Sacramento Suburban Water District, Sacramento, CA**

- *Prepared design drawings for the pump station.*

**Pixley Groundwater Banking Project, South Valley Water Banking Authority, Tulare County, CA**

**Water Meter Installation, Town of Discovery Bay, Discovery Bay, CA**

- *Provided construction administration and data analyzes for 3500-meter installations.*



---

## Appendix A-3

Professional Resumes for  
**CAW Monterey Peninsula Water Supply Project  
Design Build of Fitch Park ASR Wells 5 & 6 Above  
Ground Facilities Project Sub Consultant Team.**

**Education**

Bachelor of Architecture,  
California State Polytechnic University, San Luis Obispo, CA, 1992

Urban Design Studio (A Cal Poly 'study abroad' program)  
Czechoslovakia Technical University, Prague, Czech Republic, Summer 1992

City Planning Internship (A Cal Poly program)  
City/County of San Francisco Planning Department, 1990

**Registration**

Licensed Architect, California - No. C26227

**Contract Role**

Mr. Stowell's responsibility will be providing architectural services through the course of the project. He will be the design team lead for the structures. He will be the main contact at Silva Stowell and will rely on internal resources for production assistance.

**Selected Projects**

SMUD Field Reporting Facility-Tenant Improvements-Sacramento, CA  
SMUD Customer Service Building-Tenant Improvements-Sacramento, CA  
Beale Air Force Base-MCE Global Hawk Control Center-Beale AFB, CA  
Sacramento Regional Transit District-Bus Maintenance Facility 2, CNG Fueling Facility  
Sacramento Regional Transit District-MHRF Expansion-Sacramento, CA  
Sacramento Regional Transit District-General Engineering Support Services Contract  
Sacramento Regional Transit District-Metro Heavy Repair Facility-Sacramento, CA  
Sacramento Regional Transit District-Emergency Operations Control Room-Sac, CA  
Sacramento Municipal Utility District-Field Reporting Facility-Sacramento, CA  
California High Speed Rail Authority-Tenant Improvements-Sacramento, CA  
Sutter Maternity & Surgery Center of Santa Cruz-Special Procedures Suite  
Remodel | Addition  
Sutter Maternity & Surgery Center - Chiller Replacement - Santa Cruz  
Sutter Davis Hospital - Temporary MRI Trailer - Davis, CA  
Palo Alto Medical Foundation - Chanticleer Medical Office Building - Santa Cruz  
Palo Alto Medical Foundation - Watsonville Medical Office Building, Watsonville  
Sutter Pacific Medical Foundation Tenant Improvements-Novato, CA  
Sutter Health Information Services-Tenant Improvements-Rancho Cordova, CA  
Sutter Health Sac Sierra Region Corporate Administrative Office Tenant Improvements-Sacramento, CA  
The Bank-New Utility Services and Sidewalk Elevator-Sacramento, CA  
Granite Bay Cosmetic Surgery-Granite Bay, CA  
Legislative Data Center-Tenant Improvements-Sacramento, CA  
Kaiser Permanente-Health Connect Training Command Center-Sac, CA  
Sutter Center for Psychiatry, Remodel | Addition - Sacramento  
VA-Traumatic Brain Injury Rehabilitation Center - Martinez, CA  
Sutter Health Corporate Headquarters-Numerous Tenant Improvements-Sacramento, CA  
Sutter Health Corporate Conference Center-Fairfield, CA  
Mattress Firm-Roof Screen-Sacramento, CA

**Professional Affiliations**

Region Builders, Board of Directors  
American Institute of Architects, Member  
AIA, Central Valley Chapter - Board of Directors, 1995  
AIA | ECOS - Smart Growth Committee, Member  
City of Sacramento, Development Oversight Commission  
California Board of Architectural Examiners - Master Commissioner  
California Supplemental Examination - Standards Setting Appointee  
Sacramento Builder's Exchange - Design/Build Competition - Judge

## **General Provisions**

1. Company shall furnish all gas materials for work order(s) **SCG GD WO #54-277688**. Joint Utility materials shall be provided by the joint utility owner. In addition, Contractor shall furnish all labor and equipment required to perform the trench portion of the work in accordance with the Company Work Order Drawings and Specifications. Contractor shall base their bid on Contractor's verified lengths, quantities and field conditions required to complete the work.
2. Contractor shall be responsible for traffic control plans, ADA pedestrian control plans, implementation of those plans, and activities as required, and identify any exceptions to the plans submitted.
3. Contractor shall be responsible for all Federal, State, City and local Storm Water Pollution Programs where work is performed. Contractor shall be responsible for the installation, maintenance of, and monitoring of site BMP's and/or SWPPP (if SWPPP required) where work is performed.
4. Contractor shall be responsible for saw cutting concrete/asphalt up to 12 inches in depth. That portion of pavement removal in excess of 12 inches in depth shall be performed on a unit price basis. Contractor shall saw cut or use other approved type concrete/asphalt cutting device approved by the local municipality(s) and use continuous vacuum system and power wash area to clean debris from saw cut.
5. Contractor shall be responsible for the removal of all mark-outs per city and/or municipality requirements.
6. Contractor shall be responsible for the preservation of property line markers, historical concrete stamps, and etching of replaced sidewalk and historical concrete patterns. Concrete wheel chair ramps will be installed at all corners disturbed per municipality and ADA codes.
7. Contractor shall adhere to city, local municipality and/or permitted work hours.
8. If required, Contractor shall identify all substructures that will need dewatering and schedule testing of substructures with Pipeline Inspector's approval. Contractor shall pump after a pass on test where permitted per STP 209 and or G80210. Contractor shall provide traffic control for vault vacuuming as needed.
9. Permanent 24-hour "Construction Ahead" and "End of Construction" signs provided by Contractor shall be posted at both start and end of job and removed on completion of job.
10. Contractor shall use sand encasement and compaction in lieu of concrete slurry around all exposed foreign utilities.
11. Contractor's price shall include the "Trench Resurfacing" requirements per County and/or City.
12. Contractor to follow all County or City design and street restoration/backfill requirements per County/City standard.
13. Contractor shall ensure that all pipe is clean and capped following approval of Pipeline Inspector before moving off the job site.

14. Submit unit prices for any required additional extra/FCO work as shown below which are specific to the trench and pipe install portion of this job for SoCalGas:

**Descriptions for each are as follows:**

- a. If additional main line trench is required that is above and beyond the original scope of the job then the extra work shall be performed using the unit rate provided. Contractor has provided this unit price to Company as an "all inclusive" unit cost per linear foot of any additional main line trenching that includes but is not limited to: saw cutting, excavation, product installation, backfill and surface restoration above and beyond the original scope of the job. SoCalGas Project Manager, in their discretion, shall determine to do any or all extra main line work using this Unit, Time and Equipment or on a Lump Sum Basis.
- b. If additional service trench is required that is above and beyond the original scope of the job then the extra work shall be performed using the unit rate provided. Contractor has provided this unit price to Company as an "all inclusive" unit cost per linear foot of any additional service trenching that includes but is not limited to: saw cutting, excavation, product installation, backfill and surface restoration above and beyond the original scope of the job. SoCalGas Project Manager, in its sole discretion, shall determine to do any or all extra service trench work using this Unit, Time and Equipment or on a Lump Sum Basis.
- c. The two-person labor unit is an hourly unit for two laborers, compressor and all tools for any excavation, compaction and restoration activities. SoCalGas Project Manager, in its sole discretion, shall determine to do any or all extra work using this Unit, Time and Equipment or on a Lump Sum Basis.
- d. If additional Trench Depth is required beyond 7 feet then the extra work shall be performed using the unit rates provided. Unit rates shall be priced and performed in the following increments: 7-8Ft, 8-9Ft, +9Ft. Contractor has provided these unit prices to SoCalGas as "all inclusive" unit costs per lineal foot of any additional trench depth that includes but is not limited to: extra digging depth, material haul off, slurry, backfill, etc. (defined herein) above and beyond the original scope of the job. SoCalGas Project Manager, in their sole discretion, shall determine to do any or all extra trench depth work using these Units, Time and Equipment or on a Lump Sum Basis.
- e. If additional Grind and Cap per Square Foot is required that is above and beyond the original scope of the job then the extra work shall be performed using the unit rate provided. Contractor has provided this unit price to Company as an "all inclusive" unit cost per square foot. SoCalGas Project Manager, in its sole discretion, shall determine to do any or all extra work using this Unit, Time and Equipment or on a Lump Sum Basis.
- f. If additional Asphalt Base 0-4" thick per square foot / 4"-8" thick per square foot is required that is above and beyond the original scope of the job then the extra work shall be performed using the unit rate provided. Contractor has provided this unit

price to Company as an “all inclusive” unit cost per square foot. Company CA, in its sole discretion, shall determine to do any or all extra work using this Unit, Time and Equipment or on a Lump Sum Basis.

- g. If additional Paving per square foot (2 ft. wide) is required that is above and beyond the original scope of the job then the extra work shall be performed using the unit rate provided. Contractor has provided this unit price to Company as an “all inclusive” unit cost per square foot. SoCalGas Project Manager, in its sole discretion, shall determine to do any or all extra work using this Unit, Time and Equipment or on a Lump Sum Basis.
- h. If additional Sawcut/Pavement Removal in Excess of 12 Inch Depth (Per Lineal Foot) = 13"-15" / 16"-17"/ 18"-20" / 21"-24" is required that is above and beyond the original scope of the job then the extra work shall be performed using the unit rate provided. Contractor has provided this unit price to Company as an “all inclusive” unit cost per linear foot. SoCalGas Project Manager, in its sole discretion, shall determine to do any or all extra work using this Unit, Time and Equipment or on a Lump Sum Basis.
- i. If additional bollard installation is required that is above and beyond the original scope of the job then the extra work shall be performed using the unit rate provided. Contractor has provided this unit price to Company as an “all inclusive” unit cost per bollard that includes but is not limited to: saw cutting, excavation, product installation, backfill and surface restoration above and beyond the original scope of the job. SoCalGas Project Manager, in its sole discretion, shall determine to do any or all extra service trench work using this Unit, Time and Equipment or on a Lump Sum Basis.
  - This unit shall also be applicable when the omission of a bollard is required as dictated by the SoCalGas Pipeline Inspector with the approval of the SoCalGas Project Manager, and the Company shall receive a credit for any un-installed bollards upon final completion of job.

#### **Special Provisions**

1. Contractor shall abide by additional provisions outline in SoCalGas’ Work Authorization released to the selected contractor
2. No Material yard is provided by Company.
3. This job includes services to planned gas house line.
4. **Contractor to provide documentation showing they are qualified for hot tapping PE in the Veriforce system (screen shot) and have completed SoCalGas PE training course through SoCalGas Pico Training Dept. prior to bid closing. If Contractor is selected for the work, such qualifications must be valid throughout the performance of the Work.**
5. If applicable, any coordination with pipeline operations will be coordinated by SoCalGas Pipeline Inspector.

6. Work Hours 8AM to 4PM. Subject to change depending on park's preference.
7. Company will provide all gas materials. Contractor is responsible for picking up and returning unused materials back to the designated base.
8. Contractor to maintain all proper BMPs.
9. If Contractor decides to use native backfill, contractor is required to adhere to the applicable City's native backfill requirements. A hard copy of these requirements will be required on-site.
10. Native/ Aggregate Backfill Requirements for MHP's:
11. Compaction percentage requirements must comply with Gas Standard 184.0002, unless otherwise dictated by County/City requirements, and shall be documented on appropriate Company form
12. Compaction test locations will be selected on the main line trench per requirements outlined in Gas Standard 184.005
13. Compaction tests shall also be conducted on service trench and documented on the appropriate Company form
14. Test results will be submitted with gas as-built and each test location will be identified on the gas as-built
15. Backfill material must conform to Company standards
16. Barrier Post Installations:
17. When meter faces forward, install 3 barrier posts
18. When meter faces driveway, install 2 barrier posts
19. SoCalGas will provide all bollard for the project, and the contractor will be responsible for pickup and return of any unused bollards
20. Photo Documentation
  - a. Photo and/or Video Documentation is required for all jobs. Contractor shall provide at least two photos and/or videos: (1) site as-found, and (2) site as- left. Photos shall include surrounding ground/area specifics and/or space number that make the photos unique to the location. Photos and/or videos shall have the date and time imprinted in the photo and/or video and will be provided to the Company Pipeline Inspector or designated representative upon request. Photos and/or videos shall be identified by Work Order Number.
  - b. Other photos and/or videos are also required, such as 1 - 5 below.
    - i. Summary:
      1. As-Found – photo of pre-fielding conditions, to defend against damage claims.
      2. As-Left – photo shows a safe and clean completed job site.

3. Damaged and Repaired Facilities – photos show (a) damaged and (b) repaired conditions of underground (“UG”) facilities, components or items, regardless of ownership.
4. Damaged and Repaired Landscape – photos show (a) damaged and (b) restored conditions of landscape if not shown in other photos.
5. Abandoned Facilities – photo show pre-backfill conditions, if not shown in other photos.

**21. Substructures:**

- a. By accepting the work and submitting a proposal, Contractor agrees to take full responsibility for managing the underground utilities (existing and new) within the job site at its own risk and in accordance with sections 20 & 21 below. Contractor understands and acknowledges that records of underground utility extensions provided by the Mobile Home Park owners, SDG&E, SoCalGas, Dig Alert or tenants may be inaccurate, unavailable or may omit information entirely.

**22. Contractor assumes all responsibility for privately owned utilities.**

**23. Trenching:**

- a. Contractor shall follow all Company’s trenching standards.

**24. Gas Handling:**

- a. The dates of the tie-ins shall be determined by Contractor at least ten (10) days prior to the tie-ins. Approval of the date(s) selected shall be obtained from Company representative.

**25. If Contractor damages striping due to saw-cutting, Contractor shall repair damage**

**26. Contractor is responsible for damages that occur during construction on private property.**

**27. Contractor is responsible for locating all privately-owned utilities.**

- a. Contractor is responsible for all utility mark outs that are not covered by 811 one call service (Dig Alert).
- b. Prior to construction, Contractor is required to request in writing any as- builts or maps that the Mobile Home Park can provide in assisting with locating all private utilities within their property impacting work locations.
- c. Contractor shall identify, locate and make accessible all gas and water isolation shut off valves.
- d. Contractor is responsible for damage, repair, and restoration of any and all privately owned utilities.

**28. If damage occurs to a marked or unmarked private utility, Contractor shall:**

- a. Immediately notify Company Representative assigned to the job. Company Representative will make the proper notifications per policy and procedures.

- b. Immediately notify Owner / Manager of incident and keep updating with time of restoration and help with customer notifications.
- c. Definitions:
  - i. "Master Meter System" - Any gas system where gas is supplied through a SoCalGas master meter and distributed through customer owned facilities to the ultimate users, who may or may not be sub-metered. Common examples of projects where such a system may exist are government housing projects, mobile home parks, and apartment or commercial developments.
  - ii. "House line" - A customer owned distribution system that is downstream of a SoCalGas master meter.

### 29. Gas Emergency Action Plan

- a. **Prior to construction** and with the help of the Mobile Home Park owner or maintenance personnel, Contractor shall IDENTIFY the Master Meter Location and all private gas isolation valves and verify they are in operating condition in case of emergency.
- b. During daily safety tailgate, Contractor shall ensure that the Gas Emergency Action Plan is discussed on any day when expected excavation operations are planned or may occur or when new personnel is on site.

### 30. Repairs

- a. Contractor is responsible to promptly arrange for qualified, licensed personnel to make repairs to the private utility system as necessary.
- b. All damage caused by Contractor (and their subcontractors) working the project requires an incident report and detailed mapping of the damage location.

31. Contractor shall video tape before construction start and after construction completion.

32. All paving repairs within the Mobilehome Park shall be based on a 2' trench repair, anything above this shall be made via a Field Change Order (FCO) using the dictated pricing from the SoCalGas Project Manager and have the SoCalGas Pipeline Inspector approval and/or both Utility Inspectors approval prior to submission to the SoCalGas Project Manager

33. For asphalt public street repair, refer to standard on appropriate County website.

34. Contractor shall provide a set (1-original/1-copy) of "As Built" drawings to Company representative within ten (10) working days after the completion of work. The drawing(s) shall show and include wording that describes the actual pipeline installation or relocation details. Drawings shall show dimensions from a known property line, flood control channel, bridge, railroad, etc., to valves, angles, bends, branch connections, fittings and all other related appurtenances.

35. For billing, work packages for gas design and electric design will be separate work packages and should be treated as such. The gas and electric work are split in alignment with the Mobilehome Parks Utility Upgrade Program (MHPUUP) objectives. Whereas SDG&E’s normal work is billed heavier on the electric side, the MHPUUP applies a different split with gas taking more of the trench costs due to the nature of the program. In order to match costs/invoicing as close as possible to the desired split, Contractors must bid the job following the design packages. The designs encompass the following splits:

	Examples	Gas (%)	Electric (%)
<b>Trench Work</b>	Potting, saw-cutting, digging, shade & backfill	63	37
<b>Gas Work</b>	Pipe work (laying, fusing, etc.) & Hot Work (Gas Handling)	100	0
<b>T&amp;C Install</b>	Conduit (laying, gluing, etc.)	0	100
<b>Restoration/Paving</b>	Final asphalt/cap & grind	50	50

1. Please provide a bid that details the cost of: 1) the overall job, 2) the gas package, 3) the electric package.

For example:

1. Total: \$1,110,000
2. Gas: \$640,000= 630,000 (trench and pipe work) + 10,000 (Hot work)
3. Electric: \$470,000

2. Additionally, please keep in mind that your company’s bid is for the civil work.

a. Please adhere to the following billing percentages listed below when you submit your percentage billing:

	Section 2 Gas Task	Payment Released
1	Section 2.1 25% of Services and Mainline Completed	25%
2	Section 2.2 25% of Services and Mainline Completed	25%
3	Section 2.3 25% of Services and Mainline Completed	25%
4	Section 2.4 25% of Services and Mainline Completed	15%
5	Section 2.5 100% of Grind and Cap/Asbuilts Completed	10%
	<b><u>Total</u></b>	<b><u>100%</u></b>



# FRISCH ENGINEERING, INC.

Consulting Electrical Engineers  
13405 Folsom Blvd., Unit 600  
Folsom, CA 95630

Phone 916.353.1025

---

## Thomas P. Frisch, P.E.

---

**Experience Summary** Mr. Thomas Frisch has worked in the water/wastewater/power/landfill industry since 1991 and has developed skills in power, controls, instrumentation and communications. He has become very familiar with most practices and processes used in this industry. His experience is diverse since he has worked as a Contractor and Consultant in various capacities. As a Contractor, he brought contract drawings to completion by designing the final details, making submittals and managing production. As a Consultant, he has designed over 250 water and wastewater projects ranging from small pump stations to large scale treatment plants. Consequently he has a high degree of product knowledge that enables him to minimize design exposure to unproven materials or practices. He knows the challenges that Contractors face in taking plans to construction and knows when to assist on behalf on the Owner. His designs for electrical, instrumentation, and telemetry systems have been very successful with near-zero change orders due to design flaws. His designs include complex PLC motor controls for booster pump stations, lift stations and motor operated valves and SCADA telemetry between pump stations and tanks. He has performed electrical studies such as a damage assessment or to determine system capacity and cost comparisons to determine electrical operational costs of VFDs vs. throttled fixed speed motors

**Education** B.S. Electrical Engineering, University California Los Angeles, 1991

**Registration** Professional Electrical Engineer Reg. CA E15761, NV, NM, AZ, as needed

---

### **Work Experience** Electrical Engineer (25 years)

Mr. Frisch obtained his Professional Engineering License 1998, and shortly thereafter, began working as a consultant in Electrical Design. Thomas has designed over 250 projects ranging from small sewage lift stations to large (5000 HP total medium voltage) pump stations and water treatment plants. During this time, Mr. Frisch has become proficient as a designer, obtained the respect of his peers, and now operates a successful Electrical Engineering design and construction services business.

As a Principal at a small engineering firm, Mr. Frisch is exposed to many facets of engineering design and construction. From medium voltage distribution systems, to PLCs and instrumentation, to communications, he has obtained a vast amount of experience and can advise with confidence on any electrical issue.

He has become an authority on power distribution, arc-flash safety, and breaker coordination. Safety has become a very big issue in recent years, and he is responding with improved designs that allow maintenance while improving safety. He can review existing distribution and arc flash studies, find discrepancies, revise breaker settings, suggest modifications, and as a result, make significantly improvements.

Mr. Frisch has redesigned controls for a number of Hydroelectric facilities and understands the additional complexity with making power. In those systems, many of his engineering proficiencies are required for a successful project.

---

---

## Project Experience

<b>SCADA</b>	San Juan Water District SCADA System SMUD Carson Power Plant City of Galt WWTP Tertiary Improvements City of Galt SCADA System City of West Sacramento SCADA System Improvements City of Lincoln SCADA System
<b>Water</b>	City of Galt, Industrial Park Reservoir and BPS San Jose Water Company, Vickery Tank and PS, Franciscan Way PS, Kyburz PS, Belgatos Reservoir replacement, Cambrian Pump Station, Columbine Tanks, Overlook Tanks and Booster Pump Station, Cavanaugh Pump Station. Trinity Center WTP Lewiston RW Pump Station, WTP, and Tank California Water Service, Lucerne WTP Sacramento Suburban Enterprise Northrop BPS and Reservoir Pebble Beach CSD, Forest Lake Treatment Plant Cal Water Service Dominguez Wells 275 and 294 WTP Projects Trinity Center WTP Contra Costa Contra Loma Dam Seismic Monitoring City of Roseville, Crowder Road Flow Metering City of West Sacramento, Carlin Tank and BPS EID Promontory Tank and Reservoir 12
<b>Wells</b>	City of Davis, Well #30, Well 31 and Well 32 City of Mountain View, Well 22 City of Vacaville, Well 15 and 16, and Well 16 Ion Exchange Hex Chrome Sierra Army Depot, Well 5, 8, and 12 rehabilitation and treatment Rio Linda Water District Well 14 and Well 15
<b>Storm Water</b>	Bureau of Reclamation RD784, Pump Station #6 Bureau of Reclamation RD784, Pump Station #2,5,6,8,10 S. Olivehurst Storm Water Pump Station Yuba City Walnut Park Storm Water Pump Station RD900 Pump Station Generator Improvements

## KEY PERSONNEL - AHMAD BAYAT, P.E.



Ahmad Bayat is the founding principal of Vibro-Acoustic Consultants, with more than 25 years of extensive design and management experience. Mr. Bayat has worked on the design of low-vibration facilities for many microelectronics clients, R&D facilities, universities, and specialty structural dynamics projects. His design expertise includes finite element modeling and analysis (time history, frequency response function, modal analysis) of structures, dynamic soil-structure interaction analyses, design and specification of vibration isolation systems, and noise specification and design.

As the principal structural dynamicist, he has been responsible for developing new concepts affording robust design and major cost savings. He has published many peer-reviewed articles.

**Project Positions Held:** Project Manager; Senior Consulting Engr., Lead Senior Engr., and Structural Engr.

**Work Experience:** 2000 - present – Vibro-Acoustic Consultants (San Francisco, CA)  
1993 - 2000 – Colin Gordon & Associates (San Mateo, CA)  
1986 - 1993 – ABB Impell Corporation (Lincolnshire, IL)  
1985 - 1986 – Sargent & Lundy (Chicago, IL)

**Education:** **M.S., Civil Engineering** with emphasis in finite element analysis and structural & soil dynamics, University of Houston (Houston, Texas)  
**M.S. Thesis:** “Dynamic Two-Parameter Soil Model for Soil-Structure Interaction”  
**B.S., Civil Engineering**, (w/honors), University of Houston (Houston, Texas)

**Honors / Societies:** Registered Professional Engineer in California  
Member, Structural Engineering Association of Northern California (SEAONC)  
Member, American Society of Civil Engineers

**Publications:** “Vibration Impact of a 150-MW Cogeneration Plant on a Semiconductor Fab”, (with B. Davis), presented at ASA/INCE Baltimore, April 2010.  
“Conversion of Old Fabs/Labs - The Vibration Design Perspective”, (with B. Davis), presented at IEST ESTECH 2004 Conference, April 2004.  
“Vibration Control in Nanotechnology Research Environments”, (with B. Davis), Cleanrooms Magazine (November 2003).  
“Dynamic Characteristics of Structures Extracted from In-situ Testing”, (with H. Amick and M. Gendreau), Presented at International Society for Optical Engineering (SPIE) Conference on Current Developments in Vibration Control for Optomechanical Systems, Denver, CO (July 1999).

## MATT SNEDDON



Matt Sneddon joined VACC in 2015, bringing over thirty years' experience conducting a broad variety of acoustics and vibration consulting, research, and testing activities.

He is equally at home managing the activities of project teams, mentoring technical staff, and working hands-on in direct technical roles. Major project experience includes an extensive range of acoustic test & measurement programs, transportation and community noise studies, as well as modeling, simulation, & software development tasks. Recent activities include developing improved methods for modeling elastic wave propagation through soils, and characterizing the behavior of high transmission-loss acoustic metamaterials.

<b>Work Experience:</b>	2015-Present	<i>Consultant, Vibro-Acoustic Consultants</i>
	2009-2014	<i>Visiting Scholar, University of Southern California</i>
	2011-2013	<i>Principal Consultant, ATS Consulting</i>
	2008-2009	<i>Visiting Faculty, University of Southern California</i>
	2001-2014	<i>President, Wavefront Scientific</i>
	1991-2001	<i>Senior Scientist, Bolt Beranek and Newman</i>
	1989-1991	<i>Staff Scientist, Bolt Beranek and Newman</i>
	1986-1989	<i>Senior Consultant, Bolt Beranek and Newman</i>
1978-1986	<i>Staff Consultant, Bolt Beranek and Newman</i>	

**Education:** B.S., Physics, University of California, Santa Barbara, 1978

**Honors/Societies:** Member, Acoustical Society of America  
Member, Institute of Noise Control Engineering

**Recent Notable Projects:** **US Navy:** Testing of advanced sonar window materials  
**AiResearch Mfg.:** Gas centrifuge fault implant testing  
**Metrolink:** Subsurface vibration propagation testing  
**Hitco:** Measurements of the dynamic properties of fiber-reinforced composites  
**Caltrans:** Indoor & outdoor highway noise monitoring  
**Caltrans:** Adverse noise reflections from highway soundwalls  
**Corps of Engineers:** Noise control for airblast circuit breakers  
**US Navy:** Modal analyses of Trident sound isolation couplings  
**BBN:** Design and construction of the BBN Sonic Boom Test Facility  
**City of Millbrae:** SFO airport low-frequency noise studies  
**Chicago O'Hare:** Benchmarking noise event classification performance  
**Cessna:** Community noise predictions for engine run-up facility  
**US Dept. of Justice:** Aircraft noise modeling at NAS Oceana  
**Adams County, CO:** Denver International Airport Noise Impact Analysis  
**US Air Force:** Laboratory studies of Sonic Boom structural damage

## KEY PERSONNEL - PRATEEK KULKARNI



Prateek Kulkarni joined VACC in 2017, bringing academic experience in vibrations and elastic wave propagation in nonlinear systems. With solid experimental research background, he is proficient with CAD, FEA and testing procedures. Owing to programming and signal processing experience, he is skilled at signal analysis as applicable to system dynamics and acoustics.

He is involved with pedestal vibration analysis projects using FEA and is out in the field performing various types of vibro-acoustic testing such as ambient vibration surveys for research buildings, hospitals and so on. He applies his previous CAD, Design, Manufacturing and programming experience to overcome technical difficulties. Recent activities include developing lumped-parameter based methods for modeling elastic wave propagation through periodic resonant metamaterials and characterizing the behavior of Nonlinear and Inertant acoustic metamaterials, resulting in potential novel applications such as Directional propagation of elastic waves and Ultra-low frequency filtering.

<b>Work Experience:</b>	2017-Present	Associate, Vibro-Acoustic Consultants
	2014-2017	Graduate Research Assistant, Oklahoma State University
	2013-2014	CAD Engineer, iLensys Technologies Pvt Ltd
	2012-2013	Design Engineer, Plazma Technologies Pvt Ltd

**Education:** M.S, Mechanical and Aerospace Engineering, Oklahoma State University, Stillwater, OK, 2016

**Honors/Societies:** Member, American Society of Mechanical Engineers

**Recent Notable Projects:**

- 94<sup>th</sup> International Residential Housing: Sound Insulation measurement (STC)
- University of Washington Research Center: Ambient Vibration and Noise Measurements
- VA Medical Center: Continuous Construction Noise Monitoring
- Ochsner Medical Center: Site Vibration Survey for MRI installation
- Society of Experimental Mechanics: Nonlinear and Inertant Acoustic Metamaterials and Their device implications
- Journal of Applied Physics: Longitudinal elastic wave propagation through Inertant Acoustic Metamaterials
- 35<sup>th</sup> AIAA/ASME Conference: Direction-Biased Acoustic Metamaterial Waveguide

## Resume

William H. Merkel

Born in Sacramento, CA.

### Education

BSCE California State University, Sacramento 1968  
27 units of graduate study. 1969 --1972

### Registration

California registration as a Civil Engineer	7/71
California registration as Structural Engineer	8/75
Nevada registration as Structural Engineer	8/78
Washington registration as Civil Engineer	2/82
Arizona registration as Structural Engineer	3/82

### Employment:

Owner:	William H. Merkel Associates Structural Engineering	12/82
Partner:	Merkel/Phillips Structural and Civil Engineers	2/80-12/82
Owner:	William H. Merkel Structural Engineering	11/79-2/80
Partner:	Rumberger-Haines Structural Engineers	1/78-11/79
Owner:	William Merkel Construction Building Design &Construction	7/75-1/78
Structural Designer:	Rumberger-Haines Assistant Bridge Engineer State of California Division of Highways, Bridge Dept.	6/70-6/75 6/68-5/70

## PROFESSIONAL ORGANIZATIONS:

Member-Structural Engineers Association of California  
Past President of Structural Engineers of Central California  
Seismic Safety Council-SEA OCC Delegate  
AD-HOC Snow Loads Committee for Western United States  
Member of International Conference of Building Officials  
Member America Concrete Institute

## HOSPITALS:

Roseville Community Hospital, Roseville, CA  
Cath Lab  
Cardiac Surgery Suite  
E. R. Renovation  
Cosmetic Remodel  
Central Processing

U.C. Medical Center, University Of California, Sacramento, CA  
E. R. Renovation Room 1420  
CT Scanner Relocation  
Pharmacy Hood & Cabinets

Lodi Hospital, Lodi, CA  
E. R. Expansion  
Radiology Renovation  
X-Ray Equipment Renovation

Kaiser Hospital, Sacramento, CA/Antioch, CA/Roseville, CA  
Cath. Lab  
Library #1 & #2  
Nurse Station F Renovation  
Ophthalmology  
EKG/Cardiology

American River Hospital, Sacramento, CA  
400 Nursing Unit Remodel  
700 Telemetry Remodel  
Bulk Oxygen Replacement

Additional Projects In The Following Hospitals:

Contra Costa County Hospital  
Alta Bates Herrick Hospital  
C. H. Chope Hospital  
Lakeside Community Hospital  
Tahoe Forest Hospital  
Mercy Hospital Folsom  
Mendocino County Hospital  
Sonoma Valley Hospital  
Dominican Hospital Santa Cruz  
Mercy San Juan Hospital

GOVERNMENTAL:

McClellan AFB, North Highlands, CA  
Radar Target Building  
Building #489  
HVAC Building #2  
Environmental Lab #714  
Building #800 Addition  
Fueling Pad  
Buildings #738 & #257  
Lawrence Link Golf Course

Fort Douglas, Salt Lake City, UT  
Seismic Strengthening Building #107

Sierra Army Depot, Herlong, CA  
Building #209

San Quentin Prison  
Mechanical Upgrade

Yolo County Juvenile Hall Addition, Woodland, CA

Town hall Truss Repair, Plymouth, CA

Fire Station #2, Rancho Cordova, CA

WATER DISTRICTS:

Discovery Bay Water Treatment and Storage  
Discovery Bay, CA

Well #7  
City of Winters, CA

Burbank Park Well # 18  
City of Merced, CA

Bonita Way Well Pump Station  
Citrus Heights Water District\

River Island Water Treatment Plant  
Del Oro Water Co.

Municipal Well #20  
City of Merced, CA

SCHOOLS:

El Dorado High School, Placerville, CA  
Classroom & Library Addition

East Union High School, Manteca, CA  
Gymnasium

Grant Union High School, Sacramento, CA  
Gymnasium

## UTILITIES:

Sacramento Municipal Utility District, Sacramento, CA  
Training & Storage Building

Sacramento Municipal Utility District, Sacramento, CA  
Shops & Tool Issue Buildings

Pacific Telephone, Merced, CA  
Administrative Building

Pacific Telephone, Sacramento, CA  
Wabash Building  
Addition Number 7

Roseville Telephone, Roseville, CA  
Sunset Toll Center

## CHURCHES:

Pioneer Baptist Church, Pioneer, CA

Sun river Baptist Church, Rancho Cordova, CA

First Evangelical Free Church, Citrus Heights, CA

Presentation Church (R. C.), Stockton, CA  
Phase 1 Preliminary Design

Arcade Baptist Church, Sacramento, CA  
Cafeteria & Classroom Remodel

First Baptist Church, Woodland, CA

St. John Vianney, Rancho Cordova, CA  
Kitchen Addition  
Storage Building

## REPAIR AND RENOVATIONS:

Town & Country Bowl Truss Repair, Sacramento, CA

San Pablo Mini Mart Foundation Stabilization, San Pablo CA

810 'J' Street, Sacramento, CA

1201 'C' Street Burnout, Sacramento, CA

330 Twentieth Street Truss Repair, Sacramento, CA

Polly Pool Burnout, Sacramento, CA

Surf Building, Crescent City, CA

## RETAIL, RESTAURANTS AND WAREHOUSES:

Cable Data Building, Rancho Cordova, CA

Sprint 1 & 2, Rancho Cordova, CA

Mueller Corner Shopping Center, Sacramento, CA  
Buildings F, G & H

Factory Outlet Stores

Las Vegas, NV

Henderson, NV

Vacaville, CA

Lake Mead, CA

Rippey Building, El Dorado Hills, CA

South Napa Marketplace, Napa, CA

Appleby's Restaurants

Gold River, CA

Livermore, CA  
Daly City, CA

Burger King Restaurants  
Gilroy, CA  
Richmond, CA  
Dublin, CA  
Santa Rosa, CA  
Las Vegas, NV  
Tracy, CA  
And others

#### REFERENCES:

##### PROFESSIONAL REFERENCES:

William Staehlin -- Supervisor Structural Engineer  
O.S.H.P.D. State of California  
1600 Ninth Street, Room #420  
Sacramento, CA 95814 (916) 654-1724

Mark Colin -- Colin Construction Company  
111 Margaret Lane  
Grass Valley, CA 95945 (530) 272-3357

# Elizabeth M. Mitchell, GE

PRINCIPAL GEOTECHNICAL ENGINEER

For the past 28 years, Ms. Mitchell has provided management, development and design for a wide range of Monterey Bay geotechnical engineering projects, including various industrial facilities, public works, infrastructure, commercial buildings, schools and universities, water tanks and pipelines, forensic studies, light bridges, landslide repairs, and single and multi-family developments. Her project experience has included design and development of geotechnical investigation studies, with emphasis in the areas of complex karst conditions, coastal engineering, slope stability, liquefaction analysis, settlement analysis, identification and mitigation of structural pavement distress, expansive soil conditions, and design of deep and shallow foundation systems. Many of these projects have required interaction with local and state regulatory agencies, including DSA, CalTrans, USACE, and the California Coastal Commission.

Ms. Mitchell is well experienced in locally based development projects, including performing geotechnical engineering services for the University of California, City of Santa Cruz, City of Watsonville, County of Santa Cruz, and Cal State Monterey Bay, among others. Ms. Mitchell's experience in the Santa Cruz County area comprises over 100 projects that include geotechnical studies for academic buildings, multi-story structures, infrastructure improvements, tanks, bridges and below ground structures.

Ms. Mitchell also provides technical direction and field engineering during earthwork phases for moderate to large-scale projects and other geotechnically challenging sites. This includes exercising project management skills to resolve disputes while maintaining good client relations and the appropriate standard of care. Her project management responsibilities include supervision and peer review for department engineering and field staff.

In her role as Principal Geotechnical Engineer, Ms. Mitchell demonstrates extensive experience in the practice of geotechnical engineering and also manages complex design level and construction phase projects that include the following:

- Pajaro River Levee Remediation Study, City of Watsonville
- Monterey Peninsula Regional Desalination Plant, Marina
- Advanced Water Purification Treatment Facility, Marina
- Kresge College Feasibility and Infiltration Study, UC Santa Cruz
- Student Housing West Dormitory Buildings, UC Santa Cruz
- Environmental Health and Safety Building, UC Santa Cruz
- Coastal Biology Building, UCSC Marine Science Campus
- New Cogeneration Plant, UC Santa Cruz
- ERC Infiltration and Sinkhole Repair, UC Santa Cruz
- Academic II & III Buildings, CSU Monterey Bay
- Student Union Building, CSU Monterey Bay
- 1440 Growth Center, Scotts Valley, CA



## EDUCATION

- MS, Civil Engineering, San Jose State University
- BS, Industrial Engineering, California Polytechnic State University, San Luis Obispo

## LICENSES/REGISTRATIONS

- California Geotechnical Engineer, GE 2718
- California Civil Engineer, C58578

## CERTIFICATIONS

- ICC Soils Special Inspector No. 8029279-EC
- Qualified SWPPP Developer and Practitioner (QSD/QSP) No. 20502
- Water Treatment Operator, T2
- Water Distribution Operator, D2

## AREAS OF EXPERTISE

- Schools, Hospitals, and -Universities
- Public works, pipelines, water works projects
- Bridges, Structures, and Roadway Construction
- Coastal Engineering
- Special Geotechnical Solutions
- Special Inspection – Soil, Asphalt & Concrete
- Forensic Engineering

## PROFFESIONAL ORGANIZAIONS

- American Society of Civil Engineers
- California Geotechnical Engineers Association
- American Public Works Association
- American Water Works Association

# Matthew Maciel, PE

ASSOCIATE CIVIL ENGINEER/LABORATORY SUPERVISOR

For the past 10 years, Mr. Maciel has provided analysis, design, management and construction observation for a wide range of geotechnical engineering projects, including commercial, medical and university facilities, single and multi-family residential developments, hillside grading projects, bridges, landslide repairs, water tanks, pipelines, retaining structures, drainage and infiltration facilities, and roadways. His experience has included analysis, design and development of geotechnical investigations pertaining to karst hazards, slope stability, liquefaction, surface fault rupture, coastal erosion, settlement, pavement distress and expansive soils.

Mr. Maciel also provides technical direction and field engineering during construction phases for moderate to large-scale projects. This includes exercising project management skills to resolve disputes while maintaining good client relations and the appropriate standard of care. His project management responsibilities include supervision and peer review of field and laboratory staff.

As the laboratory supervisor, Mr. Maciel manages the daily operations of PCE's AASHTO, Caltrans and DSA certified materials testing laboratory. Management activities include quality control, test standard and contract compliance, maintenance and acquisition of laboratory and technician certifications, technician training, test mock and report development, maintenance of verification of equipment calibrations, and scheduling. Mr. Maciel also manages the radiation safety program, and is the active Radiation Safety Officer, RSO.

A partial list of recent geotechnical engineering, testing and/or inspection projects include the following:

- Kresge College Feasibility and Infiltration, UC Santa Cruz
- Student Housing West Dormitory Buildings, UC Santa Cruz
- Family Student Housing Community Project, UC Santa Cruz
- Environmental Health and Safety Building, UC Santa Cruz
- Merrill College Renovations, UC Santa Cruz
- Coastal Biology Building, UCSC Marine Science Campus
- New Cogeneration Plant, UC Santa Cruz
- ERC Infiltration and Sinkhole Repair, UC Santa Cruz
- Student Union & Redwood Building Seismic Retrofit, UCSC
- Merrill Building 8 and Cogen Retaining Walls, UC Santa Cruz
- Academic II & III Buildings, CSU Monterey Bay
- Student Union Building, CSU Monterey Bay
- Advanced Water Purification Facility, Marina
- 1440 Growth Center, Scotts Valley, CA
- Salud Para La Gente Medical Clinic Expansion, Watsonville
- Tractor Supply Company, Watsonville



## EDUCATION

- BS in Civil Engineering, California State University San Jose, CA

## LICENSES/REGISTRATIONS

- California Civil Engineer, C82779

## CERTIFICATIONS

- ICC Soils and Reinforced Concrete Special Inspector No. 8065594
- ACI Concrete Field Testing Technician – Grade 1
- ACI Concrete Strength Testing Technician – Grade 1
- NICET Geotechnical Engineering Technology Exploration, Construction, Laboratory and Generalist Level 2
- Cal Trans Certificate of Proficiency California Tests: 105, 125, 201, 202, 204, 205, 216, 217, 226, 227, 231, 308, 309, 375, 504, 518, 521, 533, 539, 540, 556, & 557
- AASHTO Tests: T11, T27, T176, T209, T275 & T329
- 8 Hour Radiation Safety Officer Training Certificate
- 40 Hour Hazardous Waste Operations and Emergency Response (HAZWOPER)
- 8 Hour Nuclear Density Gauge Certificate

## AREAS OF EXPERTISE

- Geotechnical drilling, engineering analysis and preparation of geotechnical investigations
- Construction phase project management and field engineering
- Geotechnical laboratory testing
- Special inspection

## Soma B. Goresky, PE, GE

ASSOCIATE GEOTECHNICAL ENGINEER

Ms. Goresky's experience in the fields of civil and geotechnical engineering dates back to 1986. She has worked extensively in the San Francisco Bay and Monterey Bay Area Counties. She is responsible for executing and supervising geotechnical investigations for commercial and industrial land developments, municipal public works projects, public and private schools, and single-family and residential subdivisions. She has prepared geotechnical recommendations for a wide range of structures including multistory commercial and industrial buildings, bridges, fire stations, municipal water tanks, pump stations and water distribution lines.

Ms. Goresky specializes in the investigation, evaluation and remediation of landslides and has worked closely with geologists to assess and mitigate slope stability hazards throughout the Bay Area. She also is experienced in seismic design for schools and hospitals including formulating earthquake ground motions for design, probabilistic seismic hazard analysis, and site specific ground motion hazard analysis in accordance with the California's Division of the State Architect (DSA) requirements.

In her role as Associate Geotechnical Engineer, Ms. Goresky has extensive experience in the practice of geotechnical engineering and also manages complex design level and construction phase projects that include the following:

- Pajaro Levee Remediation Study, Watsonville WWTP
- Harkins Slough Railroad Washout, Santa Cruz County
- Student Housing West Dormitory Buildings, UC Santa Cruz
- Family Student Housing Community Project, UC Santa Cruz
- Environmental Health and Safety Building, UC Santa Cruz
- Singleton Road Pedestrian Bridge and Stream Restoration, City of San Jose
- Tennant Avenue Bridge, City of Morgan Hill Public Works Department
- Page Mill Road Landslide Repair, City of Palo Alto
- Fort Ord Campground and Beach Access, California State Parks
- Upper Llagas Flood Control Project, Santa Clara Valley Water District
- Sedimentation Basins, Carnegie State Vehicular Recreational Area, California State Parks
- Newby Landfill Levee Ground Improvement, Milpitas, CA
- Cultural and Community Center, City of Morgan Hill,
- Villa Oaks Lane Landslide Repair, City of Saratoga
- Bernal Intermediate School Seismic Hazards Evaluation, Morgan Hill, CA



### EDUCATION

- MS, Civil Engineering, San Jose State University
- BS, Biology/Environmental Studies, University of California, Santa Cruz

### LICENSES/REGISTRATIONS

- California Geotechnical Engineer, GE 2252
- California Civil Engineer, CE 43959

### CERTIFICATIONS

- Water Distribution Operator, D1

### AREAS OF EXPERTISE

- Landslide Analysis and Remediation
- Bridges, Structures, and Roadway Construction
- Schools, Hospitals, and Universities

### PROFFESIONAL ORGANIZAIONS

- American Society of Civil Engineers
- California Geotechnical Engineers Association
- National Society of Professional Engineers